



Push to Connect Pneumatic



Prestolok Metal

*Swivels on Shaped Male Threads
Pre-applied Sealant
Inch & Metric Sizes
Metal Bodies*



Prestolok Composite

*Swivels on Shaped Male Threads
Pre-applied Sealant
Inch & Metric Sizes
Composite Bodies*



PrestoWeld

*Prevents Weld Spatter Build-up
Positive Tube Retention
Ease of assembly,
Flame resistant*



B

Tube to Male NPTF	W369PLP Male Elbow  Page B18	W369PLPX Extended Male Elbow  Page B19	W379PLP Male Elbow 45°  Page B20	W372PLP Branch Tee Swivel  Page B21	W371PLP Male Run Tee Swivel  Page B22	W68PLPSP Male Standpipe  Page B23
	W368PLP Male Y Connector  Page B24	W369PLPBJ Single Banjo  Page B25	W369PLPTJ Twin Banjo  Page B27	Tube to Male BSPT	W369PLP Male Elbow  Page B18	W372PLP Male Branch Tee  Page B21
Tube to Tube	32PLP Equal Union  Page B28	365PLP Union Elbow  Page B28	364PLP Union Tee  Page B29		362PLP Union Y Connector  Page B29	362PLPD Double Y Connector  Page B30
	24PLPD Double Multiple Tee  Page B31	347PLP Equal Cross  Page B31	32PLPRC Connector for 2 Tubes  Page B35	32PLPDRC Connector for 3 Tubes  Page B35	Tube to Female NPTF	377PLP Female Branch Tee Swivel  Page B22
Bulkhead Unions	32PLPBH Bulkhead Union  Page B30	32PLPBHP Plug-in Bulkhead Union  Page B36	365PLPBH Equal Bulkhead Elbow  Page B30	Plug-ins		369PLPSP Plug-In Elbow  Page B31
	379PLPSP 45° Plug-In Elbow  Page B32	372PLPSP Plug-In Branch Tee  Page B32	371PLPSP Plug-In Run Tee  Page B32		362PLPSP Plug-In Y  Page B33	67PLP Tube End Reducer  Page B34
Auxiliary Components	63PLP Double Male Union  Page B33	639PLP Plug  Page B34	Metric Tube to Male NPTF	W369PLP Male Elbow  Page B18	W372PLP Male Branch Tee Swivel  Page B21	

Metric Tube to Metric Tube	32PLP Equal Union  Page B28	365PLP Union Elbow  Page B28	364PLP Union Tee  Page B29	362PLP Union Y Connector  Page B29	362PLPD Double Y Connector  Page B30	24PLP Multiple Tee  Page B30
	24PLPD Double Multiple Tee  Page B31	347PLP Equal Cross  Page B31	32PLPRC Connector for 2 Tubes  Page B35	32PLPDRC Connector for 3 Tubes  Page B35	Metric Bulkhead Unions	32PLPBH Bulkhead Union  Page B30
Metric Tube to Male BSPT	W369PLP Male Elbow  Page B18	W369PLPX Extended Male Elbow  Page B19	W379PLP Male Elbow 45°  Page B20	W372PLP Male Branch Tee  Page B21		W371PLP Male Run Tee  Page B22
	W368PLP Male Y Connector  Page B24	W368PLPD Double Y Male Connector  Page B24	Metric Tube to Female BSPP	370PLP Female Elbow  Page B25	Metric Tube to Male BSPP	369PLP Male Elbow  Page B19
379PLP 45° Male Elbow  Page B20	372PLP Male Branch Tee  Page B22	371PLP Male Run Tee  Page B23		68PLPSP Male Standpipe  Page B23		368PLP Male Y Connector  Page B24
Metric Tube to Metric Straight Thread	369PLP Male Elbow  Page B19	369PLPX Male Elbow  Page B20	379PLP 45° Male Elbow  Page B20	372PLP Male Branch Tee  Page B22	371PLP Male Run Tee  Page B21	68PLPSP Male Standpipe  Page B23
	368PLP Male Y Connector  Page B19	Metric Banjo Fittings	W369PLPBJ Single Banjo  Page B25	369PLPBJ Banjo  Page B26	369PLPBJB Single Banjo Bodies  Page B26	32PLPDJB Double Banjo Bodies  Page B26
68BJB Single Banjo Bolt  Page B26	68BJBD Double Banjo Bolt  Page B27		68BJBT Triple Banjo Bolt  Page B27	66BJB Female Threaded Banjo Bolt  Page B27	376PLPBJ Banjo with Female Bolt  Page B27	W369PLPTJ Twin Banjo  Page B27

B

Metric Plug-Ins	369PLPSP Plug-In Elbow  Page B31	369PLPXSP Extended Plug-In Elbow  Page B32	379PLPSP 45° Plug-In Elbow  Page B32	372PLPSP Plug-In Branch Tee  Page B32	371PLPSP Plug-In Run Tee  Page B33	362PLPSP Plug-In Y  Page B33
	362PLPDSP Plug-In Multiple Y  Page B33	67PLP Tube End Reducer  Page B34	32PLPSP Tube Expander  Page B34	322PLPSP Barbed Connector  Page B35	Metric Auxiliary Components	63PLP Double Male Union  Page B33
Tube to Male NPTF	W68PLP Male Connector  Page B8	W68PLPR Male Connector Round Body  Page B9	W68PW Male Connector  Page B38	W169PLP Male Elbow Swivel  Page B11		W169PLPNS Male Elbow  Page B11
	W171PLP Male run Tee Swivel  Page B13	W171PW Male run Tee Swivel  Page B39	W172PLP Male Branch Tee Swivel  Page B14	W172PW Male Branch Tee Swivel  Page B39	Tube to Tube	62PLP Union  Page B7
164PLP Union Tee  Page B10	164PW Union Tee  Page B38	165PLP Union Elbow  Page B10	165PW Union Elbow  Page B38	Tube to Female NPTF		66PLP Female Connector  Page B8
Bulkhead Unions	62PLPBH Union Bulkhead  Page B7	66PLPBH Female Bulkhead  Page B7	62PWBH Union Bulkhead  Page B38		66PWBH Female Bulkhead  Page B38	Tube to Male BSPP
	Auxiliary Components	DB Dust/Weld Spatter Boot  Page B38	Metric Tube to Male NPTF	FPB Male connector  Page B9	C6PB Male Elbow  Page B12	
JPB Union Tee  Page B10 & B39		EPB Union Elbow  Page B11 & B40		Metric Bulkhead Unions	WBMPB Union Bulkhead  Page B7	WPB Union Bulkhead  Page B7 & B39

B

<p>Metric Tube to Male BSPT</p>	<p>F23PB Male Connector</p>  <p>Page B10</p>	<p>F3PB Male Connector</p>  <p>Page B9 & B39</p>	<p>C3PB Male Elbow Swivel</p>  <p>Page B13</p>	<p>C63LPB Extended Male Elbow</p>  <p>Page B13</p>	<p>C63PB Male Elbow Swivel</p>  <p>Page B12 & B40</p>	<p>R63PB Male Run Tee Swivel</p>  <p>Page B13 & B40</p>
<p>S63PB Male Branch Tee Swivel</p>  <p>Page B14 & B40</p>	<p>Metric Tube to Female BSPP</p>	<p>G4PB Female Connector</p>  <p>Page B8</p>	<p>WG4PB Union Female Bulkhead</p>  <p>Page B7</p>	<p>Metric Tube to Male BSPP</p>	<p>C64PB Male Elbow Swivel</p>  <p>Page B12</p>	<p>C64SPB Male Elbow Swivel</p>  <p>Page B12</p>
<p>F4PB Male Connector</p>  <p>Page B9</p>	<p>R64PB Male Run Tee Swivel</p>  <p>Page B14</p>	<p>S64PB Male Branch Tee Swivel</p>  <p>Page B15</p>	<p>Metric Tube to Metric Straight Thread</p>	<p>C68PB Male Elbow Swivel</p>  <p>Page B12</p>	<p>C68SPB Male Elbow Swivel</p>  <p>Page B13</p>	<p>F28PB Male Connector</p>  <p>Page B10</p>
<p>F8PB Male Connector</p>  <p>Page B10</p>	<p>R68PB Male Run Tee Swivel</p>  <p>Page B14</p>	<p>S68PB Male Branch Tee Swivel</p>  <p>Page B15</p>		<p>Metric Banjo Fittings</p>	<p>CORPB Single Banjo Body</p>  <p>Page B15</p>	<p>CORPBD Double Banjo Body</p>  <p>Page B15</p>
<p>COR8PBD/ COR4PBD Double Banjo</p>  <p>Page B16</p>	<p>SC4U/SC8U Single Banjo Bolt</p>  <p>Page B16</p>	<p>SC8UD/SC4UD Double Banjo Bolt</p>  <p>Page B16</p>	<p>Metric Auxiliary Components</p>		<p>TRPB Tube end Reducer</p>  <p>Page B16</p>	<p>FNPB Plug</p>  <p>Page B16 & B40</p>



Prestolok Metal Fittings

B

MATERIALS OF CONSTRUCTION	
NICKEL PLATED BODIES:	NICKEL PLATED BRASS
O-RING:	NITRILE (OTHER COMPOUNDS AVAILABLE ON REQUEST)
RELEASE BUTTON:	POLYACETAL
GRAB RING:	STAINLESS STEEL
NOTE:	FOR BRASS BODY PRESTOLOK REPLACE PLP WITH PLN

NOMENCLATURE	
EXAMPLE: W68PLP-4-2	ATTRIBUTE:
W	WHITE ACRYLIC THREAD SEALANT
68	MALE CONNECTOR
PLP	PRESTOLOK
4	1/4" (4/16) TUBE O.D.
2	1/8" (2/16) PIPE THREAD

SPECIFICATIONS	
PRESSURE RANGE:	UP TO 300 PSI DEPENDING ON TUBING
TEMPERATURE RANGE:	0° TO +200°F
NOTE:	VACUUM APPLICATIONS ARE DEPENDENT UPON TEMPERATURE AND TYPE OF TUBING USED.

TUBING SIZES	
TUBE O.D.:	1/8, 3/16, 5/32, 1/4, 5/16, 3/8, 1/2
TUBE O.D. (MM):	4,6,8,10,12,14



A compact one-piece push-to-connect fitting. Designed for low pressure circuits where assembly, disassembly and reassembly is important. Stainless steel grab ring grips the tubing to provide retention. Swivels are featured on all male pipe threaded shapes for installation in tight places and for precise positioning. Prestolok should not be used for live swivel applications. Prestolok fittings come with a pre-applied white acrylic sealant.

Recommended Tubing

Prestolok nickel plated and composite fittings are designed to be used with the following Parker Hannifin Parflex Division tubing.

TUBING SERIES	TUBING MATERIAL
E	LINEAR LOW DENSITY POLYETHYLENE
PP	POLYPROPYLENE
N	PLASTICIZED POLYAMIDE (NYLON)
NR	UNPLASTICIZED POLYAMIDE (RIGID NYLON)
U	POLYURETHANE 90 DUROMETER SHORE A
HU	POLYURETHANE 95 DUROMETER SHORE A

Other materials for Prestolok inch sized nickel plated fittings: Polyurethane 85 Durometer Shore A

CAUTION: All current manufacturers of 85A PU tubing do not approve the use of push-to-connect fittings with their product.

Testing has shown acceptable use with certain O.D – I.D. combinations. Applications and service conditions vary and therefore the use of a tube support may be required for any 85A PU tubing.

The following commercially available O.D. – I.D. 85A tubing sizes require the use of a tube support regardless of application.

5/32" – 3/32"	3/16" – 1/8"	1/4" - .170"	1/4" – 3/16"
5/16" – 1/4"	3/8" – 5/16"	1/2" – 3/8"	

Assembly Instructions

1. Cut thermoplastic tubing squarely, using Parker Tube Cutter PTC-001. Be certain the port or mating part is clean and free of debris.
2. Insert tubing into fitting until it bottoms. A slight twisting motion will ease the insertion. Pull on tubing to verify it is properly retained in the fitting.
3. To disassemble, simply push the release button against the body and remove tubing.
4. It is recommended to trim the tubing after every disassembly to insure a proper seal.

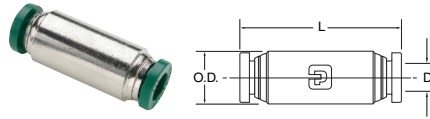

62PLP Union

PART NO.	TUBE SIZE	O.D.	L	FLOW DIA. D
62PLP-2	1/8	.375	1.40	.094
62PLP-3	3/16	.437	1.41	.156
62PLP-5/32	5/32	.375	1.41	.125
62PLP-4	1/4	.500	1.43	.188
62PLP-5	5/16	.562	1.65	.250
62PLP-6	3/8	.625	1.66	.312
62PLP-8	1/2	.750	1.82	.375

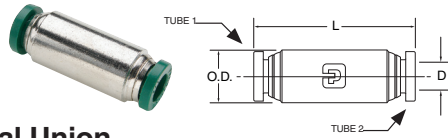

62PLP Unequal Union

PART NO.	TUBE 1 SIZE (IN)	TUBE 2 SIZE (IN)	O.D.	L	FLOW DIA. D
62PLP-5/32-2	5/32	1/8	.375	1.41	.094
62PLP-4-2	1/4	1/8	.500	1.43	.094
62PLP-4-5/32	1/4	5/32	.500	1.43	.125
62PLP-4-6	1/4	3/8	.625	1.66	.188
62PLP-6-8	3/8	1/2	.750	1.82	.312

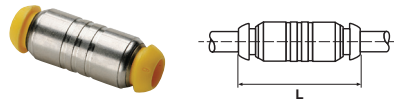

HPB Equal Union

PART NO.	TUBE SIZE (MM)	L
HPB4	4	33.0
HPB5	5	34.5
HPB6	6	36.0
HPB8	8	38.0
HPB10	10	48.0
HPB12	12	48.0
HPB14	14	54.0

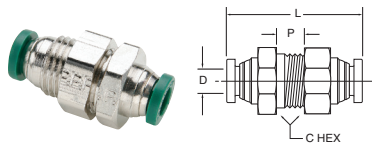

62PLPBH Bulkhead Union

PART NO.	TUBE SIZE (IN)	BULKHEAD HOLE DIA. B	C HEX	P MAX.	L	D
62PLPBH-2	1/8	7/16	9/16	.39	1.40	.094
62PLPBH-5/32	5/32	7/16	9/16	.39	1.41	.125
62PLPBH-4	1/4	9/16	11/16	.29	1.43	.188
62PLPBH-5	5/16	5/8	3/4	.60	1.65	.250
62PLPBH-6	3/8	3/4	7/8	.54	1.66	.312
62PLPBH-8	1/2	7/8	1	.66	2.04	.375

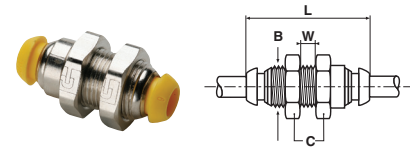

WPB Bulkhead Union

PART NO.	TUBE SIZE (MM)	B-MM THREAD	C HEX	L	W	BULKHEAD HOLE DIA.
WPB4	4	M11X0.75	16	33	6	11MM
WPB6	6	M13X1	19	35	6	13MM
WPB8	8	M15X1.25	22	36	6	16MM
WPB10	10	M18X1	22	43	8	18MM
WPB12	12	M23X1.5	27	46	10	23MM
WPB14	14	M24X1.5	30	52	10	24MM

Jam nut is supplied loose in box

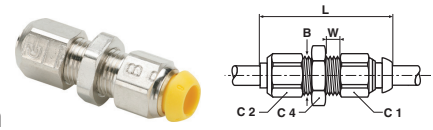

WBMPB Mixed Bulkhead Union

PART NO.	TUBE 1 SIZE (MM)	TUBE 2 SIZE (MM)	B-MM THREAD	C1	C2	C4	L	W	BULKHEAD HOLE DIA.
WBMPB4	4	4	M8X1	10	10	12	34	5	8MM
WBMPB6	6	6	M10X1	12	10	12	37	5	10MM
WBMPB8	8	8	M12X1	14	14	16	39	5	12MM
WBMPB10	10	10	M14X1	17	17	19	45	5	14MM
WBMPB12	12	12	M16X1	22	19	22	49	5	16MM
WBMPB14	14	14	M18X1	24	22	22	52	7	18MM

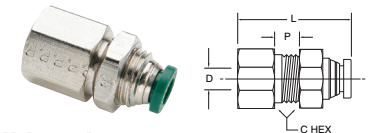

66PLPBH Female Bulkhead

PART NO.	TUBE SIZE (IN)	PIPE THD (NPTF)	C HEX	P MAX.	L	FLOW DIA. D	BKHD HOLE DIA.
66PLPBH-5/32-4	5/32	1/4	11/16	.19	1.39	.125	1/2
66PLPBH-4-4	1/4	1/4	11/16	.24	1.35	.188	9/16
66PLPBH-6-6	3/8	3/8	1	.22	1.47	.312	7/8
66PLPBH-8-6	1/2	3/8	1 1/4	.35	1.56	.344	1

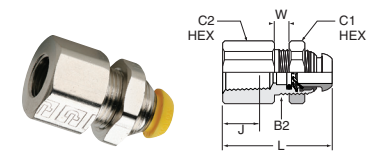

WG4PB Bulkhead Union Female BSPP

PART NUMBER	TUBE SIZE (MM)	BSPP	B2	C1 HEX	C2 HEX	J	L	W
WG4PB4-1/8	4	G1/8	M11X0.75	14	14	8	25.0	6
WG4PB6-1/8	6	G1/8	M13X1	17	17	8	25.0	6
WG4PB6-1/4	6	G1/4	M13X1	17	19	12	29.5	6
WG4PB8-1/8	8	G1/8	M15X1.25	19	17	8	25.0	6
WG4PB8-1/4	8	G1/4	M15X1.25	19	19	12	30.0	6
WG4PB10-3/8	10	G3/8	M18X1	22	22	12	34.0	8
WG4PB12-3/8	12	G3/8	M23X1.5	27	24	12	35.0	10
WG4PB12-1/2	12	G1/2	M23X1.5	27	27	14	40.0	10



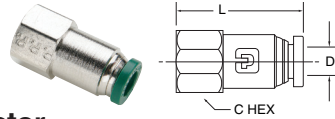

66PLP Female Connector

PART NO.	TUBE SIZE	PIPE THREAD (NPTF)	C HEX	L	FLOW DIA. D
66PLP-2-2	1/8	1/8	9/16	1.17	.094
66PLP-2-4	1/8	1/4	11/16	1.34	.094
66PLP-3-2	3/16	1/8	9/16	1.13	.156
66PLP-5/32-2	5/32	1/8	9/16	1.17	.125
66PLP-5/32-4	5/32	1/4	11/16	1.38	.125
66PLP-4-2	1/4	1/8	9/16	1.17	.188
66PLP-4-4	1/4	1/4	11/16	1.38	.188
66PLP-5-2	5/16	1/8	9/16	1.25	.250
66PLP-5-4	5/16	1/4	11/16	1.45	.250
66PLP-6-4	3/8	1/4	11/16	1.46	.312
66PLP-6-6	3/8	3/8	13/16	1.51	.312

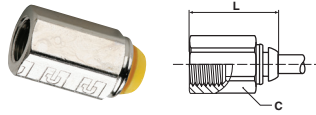

G4PB Female Connector BSPP

PART NO.	TUBE SIZE (MM)	BSPP	C HEX	L
G4PB4-1/8	4	1/8	14	26.0
G4PB6-1/8	6	1/8	14	27.5
G4PB6-1/4	6	1/4	17	33.0
G4PB8-1/8	8	1/8	17	29.0
G4PB8-1/4	8	1/4	17	33.0

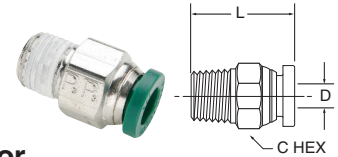

W68PLP Male Connector

PART NO.	TUBE SIZE (IN)	PIPE THD (NPTF)	C HEX	L	FLOW DIA. D
W68PLP-2-1	1/8	1/16	3/8	.79	.094
W68PLP-2-2	1/8	1/8	7/16	.79	.094
W68PLP-2-4	1/8	1/4	9/16	1.02	.094
W68PLP-3-2	3/16	1/8	7/16	.85	.156
W68PLP-3-4	3/16	1/4	9/16	1.01	.156
W68PLP-5/32-1	5/32	1/16		.88	.940
W68PLP-5/32-2	5/32	1/8	7/16	.80	.125
W68PLP-5/32-4	5/32	1/4	9/16	1.03	.125
W68PLP-4-1	1/4	1/16	1/2	1.07	.141
W68PLP-4-2	1/4	1/8	1/2	.89	.188
W68PLP-4-4	1/4	1/4	9/16	1.00	.188
W68PLP-4-6	1/4	3/8	3/4	1.04	.188
W68PLP-5-2	5/16	1/8	9/16	1.18	.250
W68PLP-5-4	5/16	1/4	9/16	1.04	.250
W68PLP-5-6	5/16	3/8	11/16	1.04	.250
W68PLP-6-2	3/8	1/8	5/8	1.21	.250
W68PLP-6-4	3/8	1/4	5/8	1.08	.312
W68PLP-6-6	3/8	3/8	11/16	1.02	.312
W68PLP-6-8	3/8	1/2	7/8	1.28	.312
W68PLP-8-4	1/2	1/4	13/16	1.44	.344
W68PLP-8-6	1/2	3/8	13/16	1.24	.344
W68PLP-8-8	1/2	1/2	7/8	1.35	.375
68PLP-5/32-4LT*	5/32	1/4-28	7/16	.88	.093

*SAE-LTthreads

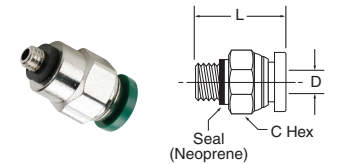

68PLP-X-0 Male Connector

PART NO.	TUBE SIZE (IN)	PIPE THREAD (NPTF)	C HEX	L	FLOW DIA. D
68PLP-2-0	1/8	10X32	3/8	.92	.094
68PLP-5/32-0	5/32	10X32			
68PLP-4-0	1/4	10X32	1/2	.96	.094

68PLPR Round Body Male Connector

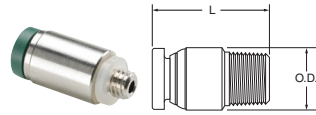

PART NO.	TUBE SIZE	THREAD SIZE NPTF	INTERNAL HEX BROACH	BODY DIA. O.D.	L	FLOW DIA.
68PLPR-2-0*	1/8	10-32	3/32	3/8"	.89	.094
68PLPR-5/32-0*	5/32	10-32	3/32	3/8"	.91	.094
68PLPR-4-0*	1/4	10-32	3/32	1/2"	.95	.094
W68PLPR-5/32-1	5/32	1/16	1/8	7/16"	.87	.125
W68PLPR-5/32-2	5/32	1/8	1/8	7/16"	.79	.125
W68PLPR-4-1	1/4	1/16	5/32	1/2"	1.06	.156
W68PLPR-4-2	1/4	1/8	3/16	1/2"	.88	.188
W68PLPR-4-4	1/4	1/4	3/16	5/8"	.99	.188

*10-32 seal is neoprene

PLPHBF4-B Male Connector BSPP

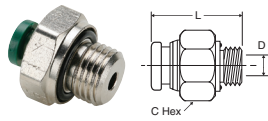

PART NO.	TUBE SIZE (IN)	PIPE THD BSPP	C HEX	L	FLOW DIA. D
3-1/8PLPHBF4-B	3/16	1/8-28	11/16	.96	.156
3-1/4PLPHBF4-B	3/16	1/4-19	3/4	.97	.156
4-1/8PLPHBF4-B	1/4	1/8-28	11/16	1.13	.188
4-1/4PLPHBF4-B	1/4	1/4-19	3/4	1.13	.188
4-3/8PLPHBF4-B	1/4	3/8-19	7/8	1.13	.188
6-1/4PLPHBF4-B	3/8	1/4-19	3/4	1.26	.256
6-3/8PLPHBF4-B	3/8	3/8-19	7/8	1.26	.312
6-1/2PLPHBF4-B	3/8	1/2-14	1-1/16	1.26	.312
8-3/8PLPHBF4-B	1/2	3/8-19	7/8	1.41	.452
8-1/2PLPHBF4-B	1/2	1/2-14	1-1/16	1.37	.452

FPB Male Connector NPT

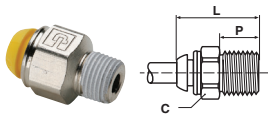

PART NO.	TUBE SIZE (MM)	NPT	C HEX	L	P	INT. HEX
W68PLP-5/32-2	4	1/8-27	7/16"	21.7	9.7	-
W68PLP-5/32-4	4	1/4-18	9/16"	28.1	14.2	-
FPB6-1/8	6	1/8-27	14	26.0	10.1	4
FPB6-1/4	6	1/4-18	14	28.5	14.6	4
FPB10-1/4	10	1/4-18	19	40.0	14.6	8
FPB10-3/8	10	3/8-18	19	34.0	14.6	8
FPB12-3/8	12	3/8-18	22	36.5	14.6	10

F3PB Male Connector BSPT

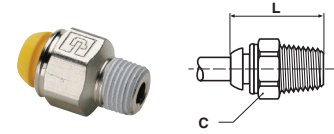

PART NO.	TUBE SIZE (MM)	BSPT	C HEX	L
F3PB4-1/8	4	1/8	10	18.4
F3PB4-1/4	4	1/4	14	20.0
F3PB5-1/8	5	1/8	11	22.0
F3PB5-1/4	5	1/4	14	23.0
F3PB6-1/8	6	1/8	12	20.7
F3PB6-1/4	6	1/4	14	20.8
F3PB8-1/8	8	1/8	14	27.5
F3PB8-1/4	8	1/4	14	26.5
F3PB8-3/8	8	3/8	17	22.5
F3PB10-1/4	10	1/4	17	32.3
F3PB10-3/8	10	3/8	17	26.3
F3PB10-1/2	10	1/2	22	26.3
F3PB12-1/4	12	1/4	20	34.3
F3PB12-3/8	12	3/8	20	29.3
F3PB12-1/2	12	1/2	22	27.3
F3PB14-3/8	14	3/8	22	38.0
F3PB14-1/2	14	1/2	22	33.0

F4PB Compact Male Connector BSPP

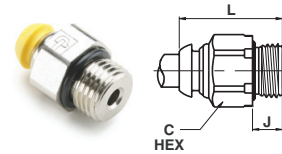

PART NO.	TUBE SIZE (MM)	BSPP	C HEX	J	L
F4PB4-1/8	4	1/8	13	4.7	19.9
F4PB4-1/4	4	1/4	16	6.0	20.3
F4PB6-1/8	6	1/8	13	4.7	23.4
F4PB6-1/4	6	1/4	16	6.0	22.2
F4PB8-1/4	8	1/4	16	6.0	23.8
F4PB8-1/8	8	1/8	14	4.7	25.1
F4PB8-3/8	8	3/8	20	6.5	23.5
F4PB10-1/4	10	1/4	17	6.0	31.3
F4PB10-3/8	10	3/8	20	6.5	26.8
F4PB10-1/2	10	1/2	24	7.5	26.1
F4PB12-1/4	12	1/4	20	6.0	31.9
F4PB12-3/8	12	3/8	20	6.5	31.8
F4PB12-1/2	12	1/2	24	7.5	27.8
F4PB14-3/8	14	3/8	22	6.5	35.0
F4PB14-1/2	14	1/2	24	7.5	30.0

B

B

F23PB Male Connector BSPT

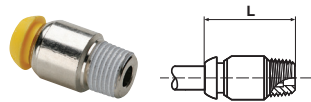

PART NO.	TUBE SIZE (MM)	BSPT	L
F23PB4-1/8	4	1/8	21
F23PB6-1/8	6	1/8	24
F23PB6-1/4	6	1/4	28
F23PB8-1/8	8	1/8	28
F23PB8-1/4	8	1/4	28

This fitting has been designed for use where space is at a premium. It is assembled using the internal hexagon and an allen key.

F28PB Male Connector Metric Straight Thread

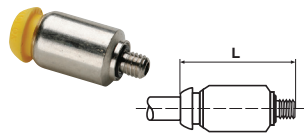

PART NO.	TUBE SIZE (MM)	MM THREAD	L
F28PB4M3	4	M3X0.5	24
F28PB4M5	4	M5X0.8	25
F28PB6M5	6	M5X0.8	25

This fitting has been designed for use where space is at a premium. It is assembled using the internal hexagon and an allen key.

F8PB Male Connector Metric Straight Thread

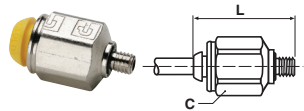

PART NO.	TUBE SIZE (MM)	MM THREAD	C HEX	L
F8PB4M5	4	M5X0.8	10	26.6
F8PB4M10	4	M10X1	14	24.0
F8PB6M5	6	M5X0.8	12	27.8
F8PB6M10	6	M10X1	14	28.0
F8PB6M12	6	M12X1.5	17	23.5
F8PB8M12	8	M12X1.5	17	27.0
F8PB8M16	8	M16X1.5	22	28.0
F8PB8M22	8	M22X1.5	27	30.0

164PLP Union Tee

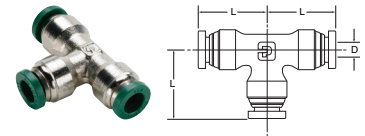

PART NO.	TUBE SIZE (IN)	L	FLOW DIA. D
164PLP-2	1/8	.74	.094
164PLP-3	3/16	.82	.156
164PLP-5/32	5/32	.77	.125
164PLP-4	1/4	.85	.188
164PLP-5	5/16	.97	.250
164PLP-6	3/8	1.01	.250
164PLP-8	1/2	1.15	.375

JPB Union Tee

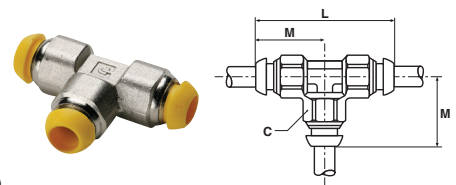

PART NO.	TUBE SIZE (MM)	C	L	M
JPB4	4	10	36	18
JPB5	5	12	41	21
JPB6	6	12	40	20
JPB8	8	14	44	22
JPB10	10	17	56	28
JPB12	12	22	60	30
JPB14	14	25	68	34

165PLP Union Elbow

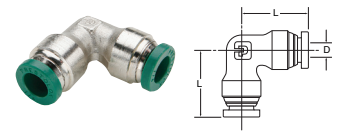

PART NO.	TUBE SIZE (IN)	L	FLOW DIA. D
165PLP-2	1/8	.74	.094
165PLP-5/32	5/32	.77	.125
165PLP-3	3/16	.82	.156
165PLP-4	1/4	.85	.188
165PLP-5	5/16	.97	.250
165PLP-6	3/8	1.01	.312
165PLP-8	1/2	1.15	.375

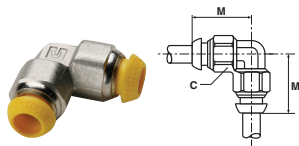

EPB 90° Union Elbow

PART NO.	TUBE SIZE (MM)	C HEX	M
EPB4	4	10	18.0
EPB5	5	12	20.5
EPB6	6	12	20.0
EPB8	8	14	22.0
EPB10	10	17	28.0
EPB12	12	22	30.0
EPB14	14	25	35.0

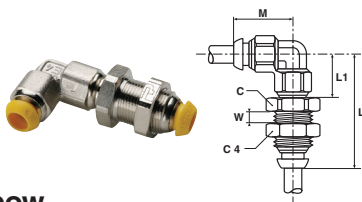

WE6PB Adjustable Bulkhead Union Elbow

PART NO.	TUBE SIZE (MM)	THREAD B (MM)	C HEX	C4 HEX	L	L1	M	W	BKHD HOLE DIA.
WE6PB4	4	M11X0.75	14	16	37	18.0	18.0	6	11MM
WE6PB6	6	M13X1	17	17	39	19.5	20.5	6	13MM
WE6PB8	8	M15X1.25	19	19	43	21.5	22.5	6	15MM
WE6PB10	10	M18X1	22	22	54	22.8	28.5	8	18MM
WE6PB12	12	M23X1.5	27	27	59	30.0	30.0	10	23MM

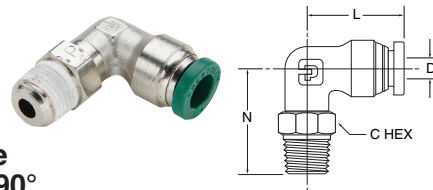

W169PLP Male Elbow Swivel 90°

PART NO.	TUBE SIZE (IN)	PIPE THREAD (NPTF)	C HEX	L	N	FLOW DIA. D
W169PLP-2-1	1/8	1/16	3/8	.74	.93	.160
W169PLP-2-2	1/8	1/8	7/16	.74	.92	.094
169PLP-2-0*	1/8	10-32	3/8	.74	.74	.080
W169PLP-2-4	1/8	1/4	9/16	.74	1.10	.094
W169PLP-3-2	3/16	1/8	7/16	.82	.92	.156
W169PLP-5/32-1	5/32	1/16	3/8	.84	.93	.160
W169PLP-5/32-2	5/32	1/8	7/16	.77	.92	.125
W169PLP-5/32-4	5/32	1/4	9/16	.77	1.10	.125
169PLP-5/32-0*	5/32	10-32	3/8	.85	.74	.080
W169PLP-4-1	1/4	1/16	3/8	.84	.93	.160
W169PLP-4-2	1/4	1/8	7/16	.85	.92	.156
W169PLP-4-4	1/4	1/4	9/16	.85	1.10	.156
W169PLP-4-6	1/4	3/8	11/16	.85	1.19	.156
169PLP-4-0*	1/4	10-32	3/8	.85	.74	.080
W169PLP-5-2	5/16	1/8	9/16	.97	1.02	.250
W169PLP-5-4	5/16	1/4	9/16	.97	1.24	.250
W169PLP-6-2	3/8	1/8	9/16	1.01	1.02	.250
W169PLP-6-4	3/8	1/4	9/16	1.01	1.24	.250
W169PLP-6-6	3/8	3/8	11/16	1.01	1.24	.250
W169PLP-6-8	3/8	1/2	7/8	1.01	1.48	.250
W169PLP-8-4	1/2	1/4	9/16	1.15	1.28	.312
W169PLP-8-6	1/2	3/8	11/16	1.15	1.31	.312
W169PLP-8-8	1/2	1/2	7/8	1.15	1.52	.312

*10-32 seal is neoprene

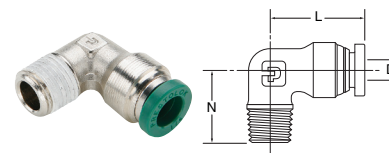

W169PLPNS Male Elbow 90°

PART NO.	TUBE SIZE (IN)	PIPE THREAD (NPTF)	L	N	FLOW DIA. D
W169PLPNS-2-2	1/8	1/8	.74	.67	.094
W169PLPNS5/32-2	5/32	1/8	.77	.67	.125
W169PLPNS5/32-4	5/32	1/4	.77	.87	.125
W169PLPNS-4-2	1/4	1/8	.85	.67	.188
W169PLPNS-4-4	1/4	1/4	.85	.87	.188
W169PLPNS-5-2	5/16	1/8	.97	.75	.234
W169PLPNS-5-4	5/16	1/4	.97	.94	.250
W169PLPNS-6-4	3/8	1/4	1.01	.94	.312
W169PLPNS-6-6	3/8	3/8	1.01	1.01	.312
W169PLPNS-6-8	3/8	1/2	1.01	1.27	.312
W169PLPNS-8-6	1/2	3/8	1.15	1.00	.375
W169PLPNS-8-8	1/2	1/2	1.15	1.27	.375
169PLPNS532-4LT*	5/32	1/4-28	.60	.48	.090

* SAE-LT Threads



B

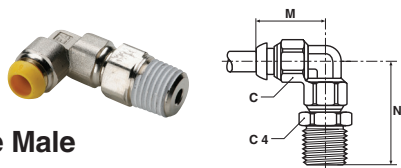

C6PB Adjustable Male Elbow NPT

PART NO.	TUBE SIZE (MM)	NPT	C HEX	C4 HEX	M	N
C6PB6-1/4	6	1/4-18	12	14	20	36.0
C6PB6-3/8	6	3/8-18	12	19	20	36.5
C6PB10-1/4	10	1/4-18	17	16	28	41.5
C6PB10-3/8	10	3/8-18	17	19	28	41.5
C6PB12-1/2	12	1/2-14	22	22	30	47.5

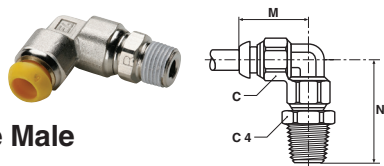

C63PB Adjustable Male Elbow BSPT

PART NO.	TUBE SIZE (MM)	BSPT	C HEX	C4 HEX	M	N
C63PB4-1/8	4	1/8	10	10	18	26.5
C63PB4-1/4	4	1/4	10	14	18	30.0
C63PB6-1/8	6	1/8	12	11	20	28.0
C63PB6-1/4	6	1/4	12	14	20	31.0
C63PB8-1/8	8	1/8	14	14	22	30.0
C63PB8-1/4	8	1/4	14	14	22	33.0
C63PB8-3/8	8	3/8	14	17	22	34.5
C63PB10-1/4	10	1/4	17	17	28	40.0
C63PB10-3/8	10	3/8	17	17	28	39.0
C63PB12-1/4	12	1/4	22	19	30	42.0
C63PB12-3/8	12	3/8	22	19	30	41.0
C63PB12-1/2	12	1/2	22	22	30	44.5
C63PB14-3/8	14	3/8	25	22	34	46.0
C63PB14-1/2	14	1/2	25	22	34	48.5

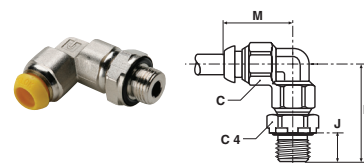

C64PB Adjustable Male Elbow BSPP

PART NO.	TUBE SIZE (MM)	BSPP	C HEX	C4 HEX	J	M	N
C64PB4-1/8	4	1/8	10	13	4.7	18	23.4
C64PB4-1/4	4	1/4	10	16	6.0	18	25.2
C64PB6-1/8	6	1/8	12	13	4.7	20	26.1
C64PB6-1/4	6	1/4	12	16	6.0	20	26.4
C64PB8-1/8	8	1/8	14	13	4.7	22	28.1
C64PB8-1/4	8	1/4	14	16	6.0	22	28.4
C64PB8-3/8	8	3/8	14	20	6.5	22	30.6
C64PB10-1/4	10	1/4	17	16	6.0	28	34.9
C64PB10-3/8	10	3/8	17	20	6.5	28	37.4
C64PB12-1/4	12	1/4	22	19	6.0	30	36.5
C64PB12-3/8	12	3/8	22	22	6.5	30	39.0
C64PB12-1/2	12	1/2	22	24	7.5	30	38.5
C64PB14-3/8	14	3/8	25	22	6.5	34	44.7
C64PB14-1/2	14	1/2	25	24	7.5	34	44.3

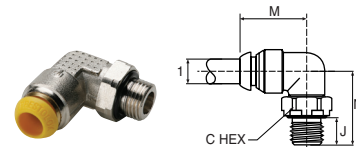

C64SPB Compact Adjustable Male Elbow BSPP

PART NUMBER	TUBE SIZE (MM)	BSPP	C HEX	J	M	N
C64SPB4-1/8	4	1/8	13	4.7	17	17.3
C64SPB6-1/8	6	1/8	13	4.7	22	17.3
C64SPB6-1/4	6	1/4	16	6.0	22	19.1
C64SPB8-1/8	8	1/8	13	4.7	24	16.9
C64SPB8-1/4	8	1/4	16	6.0	24	18.7
C64SPB8-3/8	8	3/8	20	6.5	24	20.7
C64SPB10-1/4	10	1/4	16	6.0	29	20.5
C64SPB10-3/8	10	3/8	20	6.5	29	22.5
C64SPB12-1/4	12	1/8	16	6.0	31	20.5
C64SPB12-3/8	12	3/8	20	6.5	31	23.2
C64SPB12-1/2	12	1/2	24	7.5	31	25.2

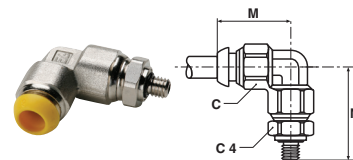

C68PB Adjustable Male Elbow Metric Straight Thread

PART NO.	TUBE SIZE (MM)	THREAD (MM)	C HEX	C4 HEX	M	N
C68PB4M5	4	M5X0.8	11	10	17	18
C68PB6M5	6	M5X0.8	11	10	17	18

B

C68SPB Compact Adjustable Male Elbow Metric Straight Thread

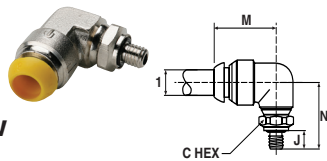

PART NUMBER	TUBE SIZE (MM)	THREAD (MM)	C HEX	J	M	N
C68SPB4M5	4	M5X0.8	12.5	5	17	18
C68SPB6M5	6	M5X0.8	12.5	5	17	18

C3PB Compact Elbow BSPT

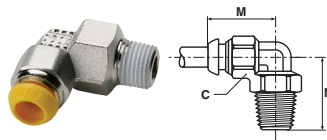

PART NO.	TUBE SIZE (MM)	BSPT	C HEX	M	N
C3PB4-1/8	4	1/8	14	18	21
C3PB6-1/8	6	1/8	14	20	21
C3PB6-1/4	6	1/4	14	20	21
C3PB8-1/8	8	1/8	14	22	23
C3PB8-1/4	8	1/4	14	22	23
C3PB10-1/4	10	1/4	17	28	26
C3PB10-3/8	10	3/8	17	28	26
C3PB12-3/8	12	3/8	17	30	27
C3PB12-1/2	12	1/2	17	30	31
C3PB14-3/8	14	3/8	20	34	30
C3PB14-1/2	14	1/2	20	34	33

C63LPB Adjustable Extended Male Elbow BSPT

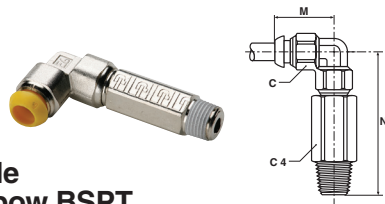

PART NO.	TUBE SIZE (MM)	BSPT	C HEX	C4 HEX	M	N
C63LPB4-1/8	4	1/8	10	10	18	42.0
C63LPB4-1/4	4	1/4	10	14	18	46.0
C63LPB6-1/8	6	1/8	12	11	20	45.5
C63LPB6-1/4	6	1/4	12	14	20	49.5
C63LPB8-1/8	8	1/8	14	14	22	50.0
C63LPB8-1/4	8	1/4	14	14	22	52.5

W171PLP Male Run Tee Swivel

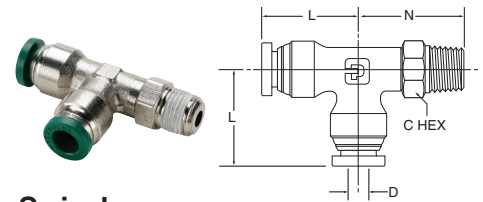

PART NO.	TUBE SIZE (IN)	PIPE THREAD (NPTF)	C HEX	L	N	FLOW DIA. D
W171PLP-2-2	1/8	1/8	7/16	.74	.92	.094
W171PLP-5/32-2	5/32	1/8	7/16	.77	.92	.125
W171PLP-4-2	1/4	1/8	7/16	.85	.92	.156
W171PLP-4-4	1/4	1/4	9/16	.85	1.10	.156
W171PLP-4-6	1/4	3/8	11/16	.85	1.24	.156
W171PLP-5-2	5/16	1/8	9/16	.97	1.02	.250
W171PLP-5-4	5/16	1/4	9/16	.97	1.24	.250
W171PLP-6-4	3/8	1/4	9/16	1.01	1.24	.250
W171PLP-6-6	3/8	3/8	11/16	1.01	1.24	.250
W171PLP-8-6	1/2	3/8	11/16	1.15	1.31	.312
W171PLP-8-8	1/2	1/2	7/8	1.15	1.52	.312

R63PB Swivel Male Run Tee BSPT

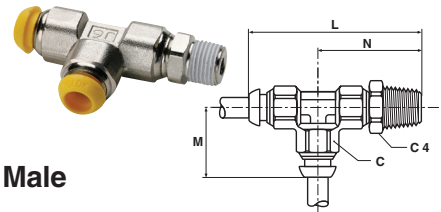

PART NO.	TUBE SIZE (MM)	BSPT	C HEX	C4 HEX	L	M	N
R63PB4-1/8	4	1/8	10	10	44.5	18	26.5
R63PB4-1/4	4	1/4	10	14	48.0	18	30.0
R63PB6-1/8	6	1/8	12	11	48.0	20	28.0
R63PB6-1/4	6	1/4	12	14	51.0	20	31.0
R63PB8-1/8	8	1/8	14	14	52.0	22	30.0
R63PB8-1/4	8	1/4	14	14	55.0	22	33.0
R63PB8-3/8	8	3/8	14	17	56.5	22	34.5
R63PB10-1/4	10	1/4	17	17	68.0	28	40.0
R63PB10-3/8	10	3/8	17	17	67.0	28	39.0
R63PB12-1/4	12	1/4	22	19	72.0	30	42.0
R63PB12-3/8	12	3/8	22	19	71.0	30	41.0
R63PB12-1/2	12	1/2	22	22	74.5	30	44.5
R63PB14-3/8	14	3/8	25	22	80.0	34	46.0
R63PB14-1/2	14	1/2	25	22	82.5	34	48.5



B

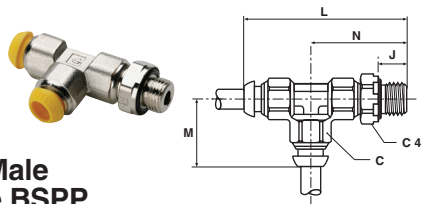

R64PB Swivel Male Branch Run Tee BSPP

PART NO.	TUBE SIZE (MM)	BSPP	C HEX	C4 HEX	J	L	M	N
R64PB4-1/8	4	1/8	10	13	4.7	41.4	18	23.4
R64PB4-1/4	4	1/4	10	16	6.0	43.2	18	25.2
R64PB6-1/8	6	1/8	12	13	4.7	46.1	20	26.1
R64PB6-1/4	6	1/4	12	16	6.0	46.4	20	26.4
R64PB8-1/8	8	1/8	14	13	4.7	50.1	22	28.1
R64PB8-1/4	8	1/4	14	16	6.0	50.4	22	28.4
R64PB8-3/8	8	3/8	14	20	6.5	52.6	22	30.6
R64PB10-1/4	10	1/4	17	16	6.0	62.9	28	34.9
R64PB10-3/8	10	3/8	17	20	6.5	65.4	28	37.4
R64PB12-1/4	12	1/4	22	19	6.0	65.5	29	36.5
R64PB12-3/8	12	3/8	22	22	6.5	68.0	29	39.0
R64PB14-3/8	14	3/8	25	22	6.5	78.7	34	44.7
R64PB14-1/2	14	1/2	25	24	7.5	78.3	34	44.3

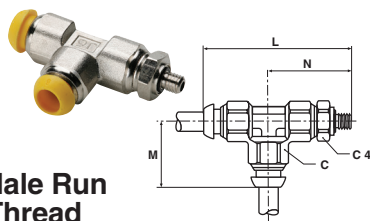

R68PB Adjustable Male Run Tee Metric Straight Thread

PART NO.	TUBE SIZE (MM)	THREAD (MM)	C HEX	C4 HEX	L	M	N
R68PB4M3	4	M3X0.5	10	10	41.0	18	23.0
R68PB4M5	4	M5X0.8	10	10	42.5	18	24.5
R68PB6M5	6	M5X0.8	12	11	45.5	20	25.5

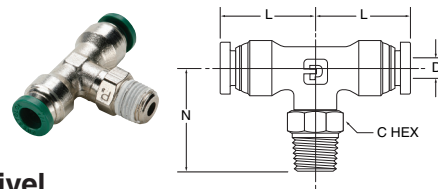

W172PLP Male Branch Tee Swivel

PART NO.	TUBE SIZE (IN)	PIPE THREAD (NPTF)	C HEX	L	N	FLOW DIA. D
W172PLP-2-2	1/8	1/8	7/16	.74	.92	.094
W172PLP-3-2	3/16	1/8	7/16	.82	.92	.156
W172PLP-5/32-2	5/32	1/8	7/16	.77	.92	.125
W172PLP-4-2	1/4	1/8	7/16	.85	.92	.156
W172PLP-4-4	1/4	1/4	9/16	.85	1.10	.156
W172PLP-4-6	1/4	3/8	11/16	.85	1.10	.156
W172PLP-5-2	5/16	1/8	9/16	.97	1.02	.250
W172PLP-5-4	5/16	1/4	9/16	.97	1.24	.250
W172PLP-6-4	3/8	1/4	9/16	1.01	1.24	.250
W172PLP-6-6	3/8	3/8	11/16	1.01	1.24	.250
W172PLP-8-4	1/2	1/4	9/16	1.15	1.30	.312
W172PLP-8-6	1/2	3/8	11/16	1.15	1.31	.312
W172PLP-8-8	1/2	1/2	7/8	1.15	1.52	.312

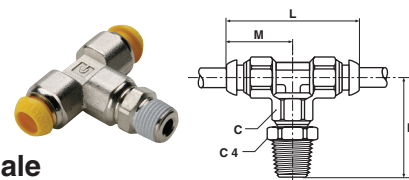

S63PB Swivel Male Branch Tee BSPT

PART NO.	TUBE SIZE (MM)	BSPT	C HEX	C4 HEX	L	M	N
S63PB4-1/8	4	1/8	10	10	36	18	26.5
S63PB4-1/4	4	1/4	10	14	36	18	30.0
S63PB6-1/8	6	1/8	12	11	40	20	28.0
S63PB6-1/4	6	1/4	12	14	40	20	31.0
S63PB8-1/8	8	1/8	14	14	44	22	30.0
S63PB8-1/4	8	1/4	14	14	44	22	33.0
S63PB8-3/8	8	3/8	14	17	44	22	34.5
S63PB10-1/4	10	1/4	17	17	56	28	40.0
S63PB10-3/8	10	3/8	17	17	56	28	39.0
S63PB12-1/4	12	1/4	22	19	60	30	42.0
S63PB12-3/8	12	3/8	22	19	60	30	41.0
S63PB12-1/2	12	1/2	22	22	60	30	44.5
S63PB14-3/8	14	3/8	25	22	68	34	46.0
S63PB14-1/2	14	1/2	25	22	68	34	48.5

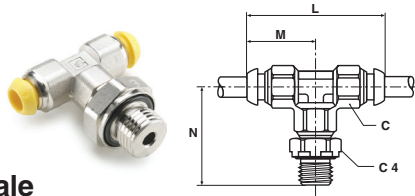

S64PB Swivel Male Branch Tee BSPP

PART NO.	TUBE SIZE (MM)	BSPP	C HEX	C4 HEX	L	M	N
S64PB4-1/8	4	1/8	10	13	36	18	23.4
S64PB4-1/4	4	1/4	10	16	36	18	25.2
S64PB6-1/8	6	1/8	12	13	40	20	26.1
S64PB6-1/4	6	1/4	12	16	40	20	26.4
S64PB8-1/8	8	1/8	14	13	44	22	28.1
S64PB8-1/4	8	1/4	14	16	44	22	28.4
S64PB8-3/8	8	3/8	14	20	44	22	30.6
S64PB10-1/4	10	1/4	17	16	56	28	34.9
S64PB10-3/8	10	3/8	17	20	56	28	37.4
S64PB12-1/4	12	1/4	22	19	58	29	36.5
S64PB12-3/8	12	3/8	22	22	58	29	39.0
S64PB14-3/8	14	3/8	25	22	68	34	44.7
S64PB14-1/2	14	1/2	25	24	68	34	44.3

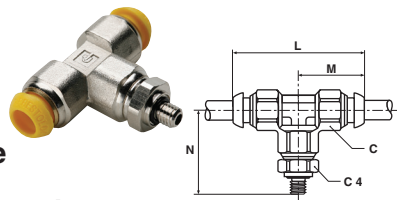

S68PB Adjustable Male Branch Tee Metric Straight Thread

PART NO.	TUBE SIZE (MM)	THREAD (MM)	C HEX	C4 HEX	L	M	N
S68PB4M3	4	M3X0.5	10	10	36	18	23.0
S68PB4M5	4	M5X0.8	10	10	36	18	24.5
S68PB6M5	6	M5X0.8	12	11	40	20	25.5

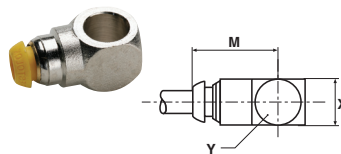

CORPB Single Banjo Body Only

PART NO.	TUBE SIZE (MM)	PART NO. SINGLE BOLT	PART NO. STACKING BOLT	M	X	Y
CORPB4-5	4	SC8UM5-4	SC8UDM5-4	19.0	10	10
CORPB4-10	4	SC4U1/8-4	SC4UD1/8-4	22.5	14	14
CORPB6-10	6	SC4U1/8-4	SC4UD1/8-4	23.0	14	14
CORPB6-13	6	SC4U1/4-6	SC4UD1/4-6	24.5	14	17
CORPB8-10	8	SC4U1/8-4	SC4UD1/8-4	24.0	14	14
CORPB8-13	8	SC4U1/4-6	SC4UD1/4-6	25.5	14	17
CORPB10-17	10	SC4U3/8-10	SC4UD3/8-10	32.0	17	22

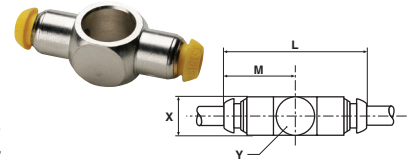

CORPBD Double Banjo Body Only

PART NO.	TUBE SIZE (MM)	PART NO. SINGLE BOLT	PART NO. STACKING BOLT	L	M	X	Y
CORPBD45	4	SC8UM5-4	SC8UDM5-4	38	19.0	10	10
CORPBD410	4	SC4U1/8-4	SC4UD1/8-4	45	22.5	14	14
CORPBD610	6	SC4U1/8-4	SC4UD1/8-4	46	23.0	14	14
CORPBD613	6	SC4U1/4-6	SC4UD1/4-6	49	24.5	14	17
CORPBD810	8	SC4U1/8-4	SC4UD1/8-4	48	24.0	14	14

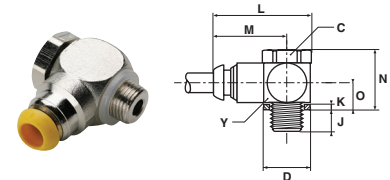

COR8PB/COR4PB Single Banjo Assembled

PART NO.	TUBE SIZE (MM)	BSPP	C HEX	D	J	K	L	M	N	O	Y
COR8PB4M5	4	M5X0.8	8	8.2	4.5	1.0	24.0	19.0	13.5	6.0	10
COR4PB4-1/8	4	1/8	14	14.4	6.0	1.5	29.5	22.5	19.5	8.5	14
COR4PB6-1/8	6	1/8	14	14.4	6.0	1.5	30.0	23.0	19.5	8.5	14
COR4PB6-1/4	6	1/4	17	18.4	9.0	2.0	33.0	24.5	21.0	9.0	17
COR4PB8-1/8	8	1/8	14	14.4	6.0	1.5	31.0	34.0	19.5	8.5	14
COR4PB8-1/4	8	1/4	17	18.4	9.0	2.0	34.0	25.5	21.0	9.0	17
COR4PB10-3/8	10	3/8	22	21.6	9.0	2.5	43.0	32.0	25.5	11.0	22

These parts are delivered complete with sealing washer.

B

B

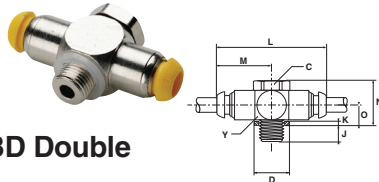

COR8PBD/COR4PBD Double Banjo Assembled

PART NO.	TUBE SIZE (MM)	BSPP	C HEX	D	J	K	L	M	N	O	Y
COR8PB4DM5	4	M5X0.8	8	8.2	4.5	1.0	38	19.0	13.5	6.0	10
COR4PB4D1/8	4	1/8	14	14.4	6.0	1.5	45	22.5	19.5	8.5	14
COR4PB6D1/8	6	1/8	14	14.4	6.0	1.5	46	23.0	19.5	8.5	14
COR4PB6D1/4	6	1/4	17	18.4	9.0	2.0	49	24.5	21.0	9.0	17
COR4PB8D1/8	8	1/8	14	14.4	6.0	1.5	48	24.0	19.5	8.5	14

These parts are delivered complete with sealing washer.

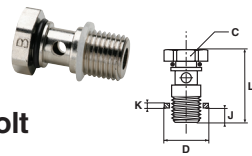

SC8U/SC4U Single Banjo Bolt with Seals BSPP

PART NO.	BSPP	C HEX	D	J	K	L
SC8UM5-4	M5X0.8	8	8.2	4.5	1.0	18.5
SC4U1/8-4	1/8	14	14.4	6.0	1.5	25.5
SC4U1/4-6	1/4	17	18.4	9.0	2.0	30.0
SC4U3/8-10	3/8	22	21.6	9.0	2.5	34.5

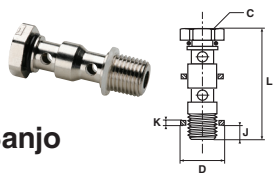

SC8UD/SC4UD Stacking Banjo Bolt with Seals BSPP

PART NO.	BSPP	C HEX	D	J	K	L
SC8UDM5-4	M5X0.8	8	8.2	4.5	1.0	29.5
SC4UD1/8-4	1/8	14	14.4	6.0	1.5	41.0
SC4UD1/4-6	1/4	17	18.4	9.0	2.0	46.0

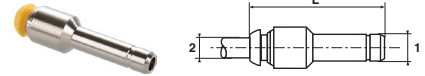

TRPB Tube End Reducer

PART NO.	TUBE 1 SIZE (MM)	TUBE 2 SIZE (MM)	L
TRPB6-4	6	4	40.0
TRPB8-4	8	4	39.5
TRPB8-6	8	6	41.5
TRPB10-4	10	4	37.0
TRPB10-6	10	6	43.0
TRPB10-8	10	8	47.5
TRPB12-6	12	6	38.0
TRPB12-8	12	8	44.0
TRPB12-10	12	10	52.0
TRPB14-8	14	8	41.0
TRPB14-10	14	10	51.0
TRPB14-12	14	12	55.0

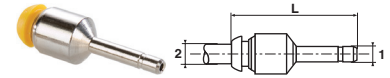

TEPB Tube End Expander

PART NO.	TUBE 1 SIZE (MM)	TUBE 2 SIZE (MM)	L
TEPB4-6	4	6	39

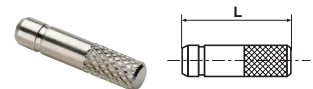

FNPB Plug

PART NO.	TUBE SIZE (MM)	L
FNPB4	4	27
FNPB6	6	27
FNPB8	8	30
FNPB10	10	30
FNPB12	12	35
FNPB14	14	36



Prestolok Composite Fittings

B

MATERIALS OF CONSTRUCTION	
BODY:	GLASS REINFORCED NYLON 6.6
COLLAR:	NYLON
GRIPPING RING:	STAINLESS STEEL
D SEAL:	NITRILE
O-RINGS:	NITRILE
BASE:	NICKEL PLATED BRASS WITH THREAD SEALANT ON TAPERED COMPONENTS AND CAPTIVE SEAL ON PARALLEL THREADS.

NOMENCLATURE	
EXAMPLE: W369PLP-4-2	ATTRIBUTE:
W	WHITE THREAD SEALANT
3	COMPOSITE BODY
69	MALE ELBOW
PLP	PRESTOLOK
4	1/4" (4/16) TUBE O.D.
2	1/8" (2/16) PIPE THREAD

PRESSURE AND TEMPERATURE RANGE	
GRIPPING RING:	-4°F TO +175°F AT UP TO 290 PSI DEPENDING ON TUBING
COLLET TECHNOLOGY:	+5°F TO +155°F AT UP TO 260 PSI DEPENDING ON TUBING
VACUUM CAPABILITY:	28" HG

APPLICABLE TUBE	
TUBE O.D.:	1/8, 5/32, 3/16, 1/4, 5/16, 3/8, 1/2
TUBE O.D. (MM):	3, 4, 6, 8, 10, 12, 14



A compact one piece push-to-connect fitting. All items in the Prestolok composite range are silicone free. The stainless steel gripping ring ensures excellent tube retention while the D seal within the fitting provides a positive seal on the O.D. of the tube, in both static and dynamic positions, due to an optimized design of the fitting cavity. Prestolok composite should not be used for live swivel applications.

Recommended Tubing

Prestolok composite fittings are designed to be used with the following tubing.

- Nylon Semi-Rigid
- Polyurethane
- Nylon
- Fluoropolymer

Assembly Instructions

1. Achieve a square cut edge with a tube cutter
2. Simply push the tubing until it can go no further. Holding and sealing is accomplished instantaneously.
3. Pull on the tubing to verify gripping action
4. To disassemble make sure there is no air flow
5. Depress the manual push button, then pull the tube out.

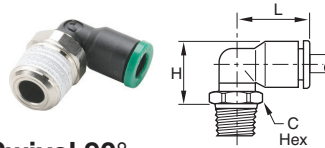

W369PLP Male Elbow Swivel 90°

PART NO.	TUBE SIZE (IN)	THREAD NPT / UNF	C HEX (MM)	L	H
369PLP-2-0	1/8	10-32	8	0.57	0.52
W369PLP-2-1	1/8	1/16	10	0.57	0.53
W369PLP-2-2	1/8	1/8	11	0.57	0.53
W369PLP-2-4	1/8	1/4	14	0.57	0.55
369PLP-5/32-0	5/32	10-32	8	0.55	0.53
W369PLP-5/32-2	5/32	1/8	11	0.55	0.53
W369PLP-5/32-4	5/32	1/4	14	0.55	0.55
W369PLP-3-2	3/16	1/8	11	0.85	0.67
369PLP-4-0	1/4	10-32	11	0.71	0.63
W369PLP-4-2	1/4	1/8	11	0.71	0.67
W369PLP-4-4	1/4	1/4	14	0.71	0.63
W369PLP-4-6	1/4	3/8	18	0.71	0.65
W369PLP-5-2	5/16	1/8	11	0.91	0.75
W369PLP-5-4	5/16	1/4	14	0.91	0.71
W369PLP-5-6	5/16	3/8	18	0.91	0.73
W369PLP-6-2	3/8	1/8	15	1.08	0.91
W369PLP-6-4	3/8	1/4	15	1.08	0.91
W369PLP-6-6	3/8	3/8	18	1.08	0.87
W369PLP-6-8	3/8	1/2	22	1.08	0.91
W369PLP-8-4	1/2	1/4	20	1.38	1.22
W369PLP-8-6	1/2	3/8	20	1.38	1.22
W369PLP-8-8	1/2	1/2	24	1.38	1.12

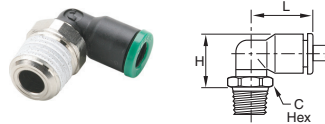

W369PLP Male Elbow Swivel 90° - BSPT

PART NO.	TUBE SIZE (IN)	THREAD BSPT	C HEX (MM)	L	H
W369PLP-2-2R	1/8	1/8	10	0.57	0.53
W369PLP-5/32-2R	5/32	1/8	10	0.55	0.53
W369PLP-5/32-4R	5/32	1/4	14	0.55	0.55
W369PLP-3-2R	3/16	1/8	11	0.85	0.67
W369PLP-4-2R	1/4	1/8	10	0.71	0.67
W369PLP-4-4R	1/4	1/4	14	0.71	0.63
W369PLP-5-2R	5/16	1/8	10	0.91	0.75
W369PLP-5-4R	5/16	1/4	14	0.91	0.71
W369PLP-5-6R	5/16	3/8	17	0.91	0.71
W369PLP-5-8R	5/16	1/2	21	0.91	0.77
W369PLP-6-4R	3/8	1/4	15	1.04	0.87
W369PLP-6-6R	3/8	3/8	17	1.04	0.87
W369PLP-8-4R	1/2	1/4	20	1.38	1.22
W369PLP-8-6R	1/2	3/8	20	1.38	1.22
W369PLP-8-8R	1/2	1/2	24	1.38	1.12

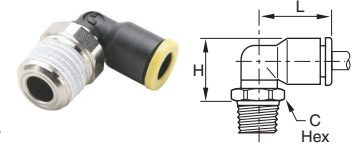

W369PLP Male Elbow

PART NO.	TUBE SIZE (MM)	THREAD NPT	C HEX (MM)	H	L
W369PLP-4M-2	4	1/8	11	0.5	0.6
W369PLP-4M-4	4	1/4	14	0.6	0.6
W369PLP-6M-2	6	1/8	11	0.6	0.6
W369PLP-6M-4	6	1/4	14	0.6	0.6
W369PLP-8M-2	8	1/8	11	0.8	0.9
W369PLP-8M-4	8	1/4	14	0.7	0.9
W369PLP-8M-6	8	3/8	18	0.7	0.9
W369PLP-10M-4	10	1/4	15	0.9	1.0
W369PLP-10M-6	10	3/8	18	0.9	1.0
W369PLP-10M-8	10	1/2	22	0.9	1.0
W369PLP-12M-6	12	3/8	18	1.0	1.2
W369PLP-12M-8	12	1/2	22	1.0	1.2

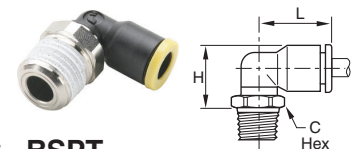

W369PLP Male Elbow - BSPT

PART NO.	TUBE SIZE (MM)	THREAD BSPT	C HEX (MM)	H	L
W369PLP-4M-2R	4	1/8	10	13.5	14.0
W369PLP-4M-4R	4	1/4	14	14.0	14.0
W369PLP-4M-6R	4	3/8	17	13.5	14.0
W369PLP-6M-2R	6	1/8	10	15.5	16.0
W369PLP-6M-4R	6	1/4	14	16.0	16.0
W369PLP-6M-6R	6	3/8	17	16.0	16.0
W369PLP-6M-8R	6	1/2	21	16.5	16.0
W369PLP-8M-2R	8	1/8	10	19.0	23.0
W369PLP-8M-4R	8	1/4	14	18.0	23.0
W369PLP-8M-6R	8	3/8	17	18.0	23.0
W369PLP-8M-8R	8	1/2	21	19.5	23.0
W369PLP-10M-2R	10	1/8	15	23.0	26.5
W369PLP-10M-4R	10	1/4	15	22.0	26.5
W369PLP-10M-6R	10	3/8	17	22.0	26.5
W369PLP-10M-8R	10	1/2	21	22.0	26.5
W369PLP-12M-4R	12	1/4	15	25.0	31.0
W369PLP-12M-6R	12	3/8	17	25.0	31.0
W369PLP-12M-8R	12	1/2	21	25.0	31.0
W369PLP-14M-6R	14	3/8	20	30.5	35.5
W369PLP-14M-8R	14	1/2	24	28.5	35.5

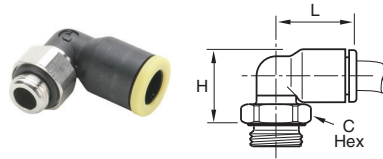

369PLP Male Elbow - BSPP

PART NO.	TUBE SIZE (MM)	BSPP / METRIC	C HEX (MM)	H	L
369PLP-3M-M3	3	M3X0.5	8	15.0	14.5
369PLP-3M-M5	3	M5X0.8	8	13.5	14.5
369PLP-4M-M3	4	M3X0.5	8	15.0	14.5
369PLP-4M-M5	4	M5X0.8	8	13.5	14.0
369PLP-4M-M7	4	M7X1	10	15.0	14.0
369PLP-4M-2G	4	1/8	13	13.0	14.0
369PLP-4M-4G	4	1/4	16	13.0	14.0
369PLP-6M-M5	6	M5X0.8	8	15.5	16.0
369PLP-6M-M7	6	M7X1	10	17.5	16.0
369PLP-6M-M10	6	M10X1	13	15.0	14.0
369PLP-6M-M12	6	M12X1.5	15	15.0	16.0
369PLP-6M-2G	6	1/8	13	15.0	16.0
369PLP-6M-4G	6	1/4	16	15.0	16.0
369PLP-6M-6G	6	3/8	20	15.5	16.0
369PLP-6M-8G	6	1/2	24	16.0	16.0
369PLP-8M-M10	8	M10X1	13	20.5	23.0
369PLP-8M-M12	8	M12X1.5	15	19.5	23.0
369PLP-8M-2G	8	1/8	13	20.5	23.0
369PLP-8M-4G	8	1/4	16	18.5	23.0
369PLP-8M-6G	8	3/8	20	18.5	23.0
369PLP-8M-8G	8	1/2	24	19.0	23.0
369PLP-10M-4G	10	1/4	16	23.5	26.5
369PLP-10M-6G	10	3/8	20	22.0	26.5
369PLP-10M-8G	10	1/2	24	22.0	26.5
369PLP-12M-4G	12	1/4	16	26.5	31.0
369PLP-12M-6G	12	3/8	20	25.0	31.0
369PLP-12M-8G	12	1/2	24	25.0	31.0
369PLP-14M-6G	14	3/8	20	32.5	35.5
369PLP-14M-8G	14	1/2	24	27.0	35.5

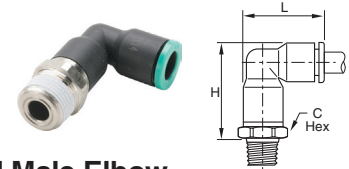

W369PLPX Extended Male Elbow

PART NO.	TUBE SIZE (IN)	THREAD NPT / UNF	C HEX (MM)	H	L
369PLPX-2-0	1/8	10-32	8	0.91	0.75
W369PLPX-2-2	1/8	1/8	11	0.91	0.75
W369PLPX-2-4	1/8	1/4	14	0.93	0.75
369PLPX-5/32-0	5/32	10-32	8	0.91	0.75
W369PLPX-5/32-2	5/32	1/8	11	0.91	0.75
W369PLPX-5/32-4	5/32	1/4	14	0.93	0.75
369PLPX-4-0	1/4	10-32	11	1.10	0.93
369PLPX-4-M7	1/4	M7	9	1.17	0.93
W369PLPX-4-2	1/4	1/8	11	1.12	0.93
W369PLPX-4-4	1/4	1/4	14	1.08	0.93
W369PLPX-4-6	1/4	3/8	17	1.12	0.93
W369PLPX-5-2	5/16	1/8	13	1.32	1.16
W369PLPX-5-4	5/16	1/4	14	1.28	1.16
W369PLPX-6-2	3/8	1/8	17	1.40	1.34
W369PLPX-6-4	3/8	1/4	17	1.41	1.33
W369PLPX-6-6	3/8	3/8	18	1.45	1.33

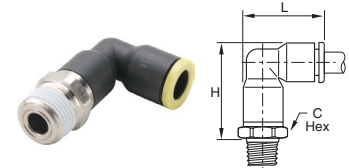

W369PLPX Extended Male Elbow - BSPT

PART NO.	TUBE SIZE (MM)	THREAD BSPT	C HEX (MM)	H	L
W369PLPX-4M-2R	4	1/8	10	23.0	19.0
W369PLPX-4M-4R	4	1/4	14	23.5	19.0
W369PLPX-6M-2R	6	1/8	10	27.0	22.5
W369PLPX-6M-4R	6	1/4	14	27.5	22.5
W369PLPX-8M-2R	8	1/8	13	34.5	29.5
W369PLPX-8M-4R	8	1/4	14	32.5	29.5
W369PLPX-8M-6R	8	3/8	17	33.0	29.5
W369PLPX-10M-4R	10	1/4	15	39.5	34.5
W369PLPX-10M-6R	10	3/8	17	39.5	34.5
W369PLPX-10M-8R	10	1/2	21	39.5	34.5
W369PLPX-12M-4R	12	1/4	19	45.5	40.5
W369PLPX-12M-6R	12	3/8	19	45.5	40.5
W369PLPX-12M-8R	12	1/2	21	45.5	40.5
W369PLPX-14M-6R	14	3/8	21	51.5	46.5
W369PLPX-14M-8R	14	1/2	21	51.5	46.5



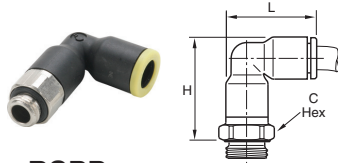

369PLPX Male Elbow - BSPP

PART NO.	TUBE SIZE (MM)	BSPP / METRIC	C HEX (MM)	H
369PLPX-4M-M5	4	M5X0.8	8	23.0
369PLPX-4M-M7	4	M7X1	10	22.5
369PLPX-4M-2G	4	1/8	13	22.5
369PLPX-4M-4G	4	1/4	16	22.5
369PLPX-6M-M5	6	M5X0.8	10	27.5
369PLPX-6M-M7	6	M7X1	10	26.0
369PLPX-6M-2G	6	1/8	13	27.0
369PLPX-6M-4G	6	1/4	16	27.0
369PLPX-8M-2G	8	1/8	13	36.0
369PLPX-8M-4G	8	1/4	16	33.0
369PLPX-8M-6G	8	3/8	20	33.0
369PLPX-10M-4G	10	1/4	16	40.5
369PLPX-10M-6G	10	3/8	20	40.5
369PLPX-10M-8G	10	1/2	24	40.5
369PLPX-12M-4G	12	1/4	19	44.5
369PLPX-12M-6G	12	3/8	20	42.0
369PLPX12M-8G	12	1/2	24	42.0
369PLPX-14M-6G	14	3/8	22	51.0
369PLPX-14M-8G	14	1/2	24	48.5

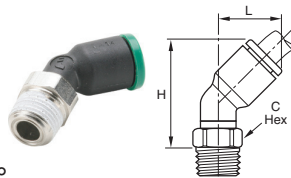

W379PLP Male Elbow 45°

PART NO.	TUBE SIZE (IN)	THREAD NPT / UNF	C HEX (MM)	H	L
379PLP-2-0	1/8	10-32	8	0.91	0.49
W379PLP-2-2	1/8	1/8	11	0.81	0.49
W379PLP-4-2	1/4	1/8	11	0.98	0.57
W379PLP-4-4	1/4	1/4	14	0.98	0.57
W379PLP-4-M7	1/4	M7	9	1.14	0.57
W379PLP-6-4	3/8	1/4	17	1.36	0.91
W379PLP-6-6	3/8	3/8	18	1.36	0.91

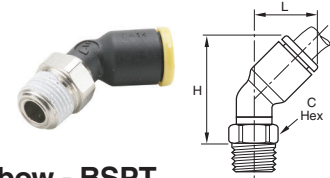

W379PLP 45° Male Elbow - BSPT

PART NO.	TUBE SIZE (MM)	BSPT	C HEX (MM)	H	L
W379PLP-4M-2R	4	1/8	10	24.5	13.0
W379PLP-6M-2R	6	1/8	10	28.0	14.5
W379PLP-6M-4R	6	1/4	14	30.0	14.5
W379PLP-8M-2R	8	1/8	10	33.5	19.5
W379PLP-8M-4R	8	1/4	14	33.5	19.5
W379PLP-8M-6R	8	3/8	17	33.5	19.5
W379PLP-10M-4R	10	1/4	15	38.5	23.0
W379PLP-10M-6R	10	3/8	17	39.0	23.0
W379PLP-10M-8R	10	1/2	21	40.5	23.0
W379PLP-12M-4R	12	1/4	15	44.0	26.0
W379PLP-12M-6R	12	3/8	17	44.0	26.0
W379PLP-12M-8R	12	1/2	21	46.0	26.0

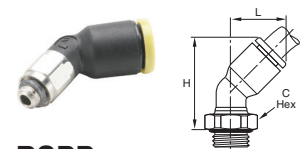

379PLP 45° Male Elbow - BSPP

PART NO.	TUBE SIZE (MM)	BSPP / M5	C HEX (MM)	H	L
379PLP-4M-M5	4	M5X0.8	8	23.0	13.0
379PLP-4M-2G	4	1/8	13	25.0	13.0
379PLP-6M-M5	6	M5X0.8	8	30.0	14.5
379PLP-6M-2G	6	1/8	13	28.5	14.5
379PLP-6M-4G	6	1/4	16	29.5	14.5
379PLP-8M-2G	8	1/8	13	36.0	19.5
379PLP-8M-4G	8	1/4	16	34.5	19.5
379PLP-8M-6G	8	3/8	20	34.5	19.5
379PLP-10M-4G	10	1/4	16	40.5	23.0
379PLP-10M-6G	10	3/8	20	39.0	23.0
379PLP-10M-8G	10	1/2	24	41.0	23.0
379PLP-12M-4G	12	1/4	16	46.0	26.0
379PLP-12M-6G	12	3/8	20	44.5	26.0
379PLP-12M-8G	12	1/2	24	46.0	26.0

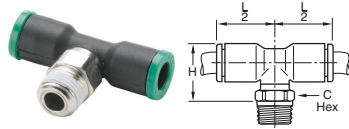

W372PLP Male Branch Tee Swivel

PART NO.	TUBE SIZE (IN)	THREAD NPT / UNF	C HEX (MM)	L/2	H
372PLP-2-0	1/8	10-32	8	0.57	0.61
W372PLP-2-1	1/8	1/16	10	0.57	0.61
W372PLP-2-2	1/8	1/8	11	0.57	0.61
W372PLP-2-4	1/8	1/4	14	0.57	0.63
372PLP-5/32-0	5/32	10-32	8	0.55	0.71
W372PLP-5/32-2	5/32	1/8	11	0.55	0.61
W372PLP-5/32-4	5/32	1/4	14	0.55	0.63
W372PLP-3-2	3/16	1/8	11	0.85	0.67
W372PLP-4-2	1/4	1/8	11	0.71	0.67
W372PLP-4-4	1/4	1/4	14	0.71	0.63
W372PLP-4-6	1/4	3/8	18	0.71	0.65
W372PLP-5-2	5/16	1/8	11	0.91	0.87
W372PLP-5-4	5/16	1/4	14	0.91	0.83
W372PLP-5-6	5/16	3/8	18	0.91	0.85
W372PLP-6-2	3/8	1/8	15	1.04	0.99
W372PLP-6-4	3/8	1/4	15	1.04	0.99
W372PLP-6-6	3/8	3/8	18	1.04	0.95
W372PLP-6-8	3/8	1/2	22	1.04	0.98
W372PLP-8-4	1/2	1/4	20	1.38	1.22
W372PLP-8-6	1/2	3/8	20	1.38	1.22
W372PLP-8-8	1/2	1/2	24	1.38	1.21

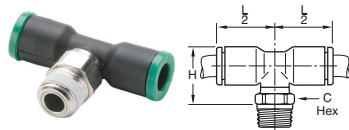

W372PLP Male Branch Tee - BSPT

PART NO.	TUBE SIZE (IN)	THREAD BSPT	C HEX (MM)	L/2	H
W372PLP-2-2R	1/8	1/8	10	0.55	0.61
W372PLP-5/32-2R	5/32	1/8	10	0.55	0.61
W372PLP-5/32-4R	5/32	1/4	14	0.55	0.63
W372PLP-3-2R	3/16	1/8	11	0.85	0.67
W372PLP-3-4R	3/16	1/4	14	0.85	0.67
W372PLP-4-2R	1/4	1/8	10	0.71	0.67
W372PLP-4-4R	1/4	1/4	14	0.71	0.63
W372PLP-5-2R	5/16	1/8	10	0.91	0.87
W372PLP-5-4R	5/16	1/4	14	0.91	0.83
W372PLP-5-6R	5/16	3/8	17	0.91	0.83
W372PLP-6-4R	3/8	1/4	15	1.04	0.95
W372PLP-6-6R	3/8	3/8	17	1.04	0.95
W372PLP-8-4R	1/2	1/4	20	1.38	1.24
W372PLP-8-6R	1/2	3/8	20	1.38	1.22

W372PLP Male Branch Tee - NPT

PART NO.	TUBE SIZE (MM)	NPT	C HEX (MM)	H	L/2
W372PLP-4M-2	4	1/8	11	0.61	0.55
W372PLP-4M-4	4	1/4	14	0.63	0.55
W372PLP-6M-2	6	1/8	11	0.69	0.63
W372PLP-6M-4	6	1/4	14	0.71	0.63
W372PLP-8M-2	8	1/8	11	0.87	0.91
W372PLP-8M-4	8	1/4	14	0.83	0.91
W372PLP-8M-6	8	3/8	18	0.85	0.91
W372PLP-10M-4	10	1/4	15	0.98	1.04
W372PLP-10M-6	10	3/8	18	0.95	1.04
W372PLP-10M-8	10	1/2	22	0.98	1.04
W372PLP-12M-6	12	3/8	18	1.06	1.22
W372PLP-12M-8	12	1/2	22	0.98	1.22

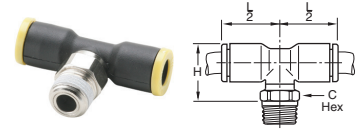

W372PLP Male Branch Tee - BSPT

PART NO.	TUBE SIZE (MM)	BSPT	C HEX (MM)	H	L/2
W372PLP4M-2R	4	1/8	10	15.5	14.0
W372PLP-4M-4R	4	1/4	14	16.0	14.0
W372PLP-6M-2R	6	1/8	10	17.5	16.0
W372PLP-6M-4R	6	1/4	14	18.0	16.0
W372PLP-8M-2R	8	1/8	10	22.0	23.0
W372PLP-8M-4R	8	1/4	14	21.0	23.0
W372PLP-8M-6R	8	3/8	17	21.0	23.0
W372PLP-10M-4R	10	1/4	15	24.0	26.5
W372PLP-10M-6R	10	3/8	17	24.0	26.5
W372PLP-10M-8R	10	1/2	21	24.0	26.5
W372PLP-12M-4R	12	1/4	15	27.0	31.0
W372PLP-12M-6R	12	3/8	17	27.0	31.0
W372PLP-12M-8R	12	1/2	21	27.0	31.0
W372PLP-14M-6R	14	3/8	20	30.5	35.5
W372PLP-14M-8M	14	1/2	24	28.5	35.5



B

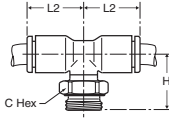

372PLP Male Branch Tee - BSPP

PART NO.	TUBE SIZE (MM)	BSPP / M5	C HEX (MM)	H	L/2
372PLP-4M-M5	4	M5X0.8	8	17.5	14.0
372PLP-4M-2G	4	1/8	13	15.0	14.0
372PLP-4M-4G	4	1/4	16	15.0	14.0
372PLP-6M-M5	6	M5X0.8	8	19.5	16.0
372PLP-6M-2G	6	1/8	13	17.0	16.0
372PLP-6M-4G	6	1/4	16	17.0	16.0
372PLP-8M-2G	8	1/8	13	23.5	23.0
372PLP-8M-4G	8	1/4	16	21.5	23.0
372PLP-8M-6G	8	3/8	20	21.5	23.0
372PLP10M-4G	10	1/4	16	26.0	26.5
372PLP-10M-6G	10	3/8	20	24.0	26.5
372PLP-10M-8G	10	1/2	24	24.0	26.5
372PLP-12M-4G	12	1/4	16	29.0	31.0
372PLP-12M-6G	12	3/8	20	27.0	31.0
372PLP-12M-8G	12	1/2	24	27.0	31.0
372PLP-14M-6G	14	3/8	20	32.5	35.5
372PLP-14M-8G	14	1/2	24	27.0	35.5

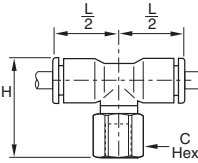
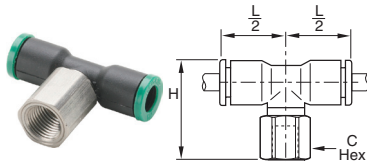

377PLP Female Branch Tee Swivel

PART NO.	TUBE SIZE (IN)	THREAD NPT / UNF	C HEX (MM)	L/2	H
377PLP-2-2	1/8	1/8	13	0.57	0.99
377PLP-5/32-2	5/32	1/8	13	0.55	0.91
377PLP-5/32-4	5/32	1/4	16	0.55	1.08
377PLP-4-2	1/4	1/8	13	0.71	1.02
377PLP-4-4	1/4	1/4	16	0.71	1.18
377PLP-5-2	5/16	1/8	13	0.91	1.24
377PLP-5-4	5/16	1/4	16	0.91	1.40
377PLP-6-4	3/8	1/4	16	1.04	1.60
377PLP-8-6	1/2	3/8	22	1.38	1.88

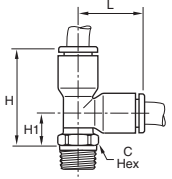

W371PLP Male Run Tee Swivel

PART NO.	TUBE SIZE (IN)	THREAD NPT / UNF	C HEX (MM)	L	H	H1
371PLP-2-0	1/8	10-32	8	0.57	0.92	0.35
W371PLP-2-1	1/8	1/16	10	0.57	0.93	0.35
W371PLP-2-2	1/8	1/8	11	0.57	0.93	0.35
371PLP-5/32-0	5/32	10-32	8	0.57	1.02	0.45
W371PLP-5/32-2	5/32	1/8	11	0.57	0.93	0.53
W371PLP-5/32-4	5/32	1/4	14	0.57	0.94	0.37
W371PLP-3-2	3/16	1/8	11	0.85	1.31	0.45
W371PLP-4-2	1/4	1/8	11	0.69	1.16	0.45
W371PLP-4-4	1/4	1/4	14	0.69	1.12	0.41
W371PLP-4-6	1/4	3/8	18	0.69	1.14	0.43
W371PLP-5-2	5/16	1/8	11	0.91	1.38	0.49
W371PLP-5-4	5/16	1/4	14	0.91	1.34	0.45
W371PLP-5-6	5/16	3/8	18	0.91	1.36	0.47
W371PLP-6-2	3/8	1/8	15	1.04	1.63	0.60
W371PLP-6-4	3/8	1/4	15	1.04	1.63	0.60
W371PLP-6-6	3/8	3/8	18	1.04	1.60	0.55
W371PLP-6-8	3/8	1/2	22	1.04	1.63	0.59
W371PLP-8-4	1/2	1/4	20	1.38	2.17	0.79
W371PLP-8-6	1/2	3/8	20	1.38	2.17	0.79
W371PLP-8-8	1/2	1/2	24	1.38	2.07	0.79

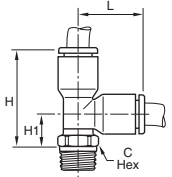

W371PLP Male run Tee - BSPT

PART NO.	TUBE SIZE (MM)	THREAD BSPT	C HEX (MM)	H	H1	L
W371PLP-4M-2R	4	1/8	10	23.5	9.0	14.5
W371PLP-4M-4R	4	1/4	14	24.0	9.5	14.5
W371PLP-6M-2R	6	1/8	10	27.5	10.0	17.5
W371PLP-6M-4R	6	1/4	14	28.0	10.5	17.5
W371PLP-8M-2R	8	1/8	10	35.0	12.0	23.0
W371PLP-8M-4R	8	1/4	14	34.0	11.0	23.0
W371PLP-8M-6R	8	3/8	17	34.0	11.0	23.0
W371PLP-10M-4R	10	1/4	15	40.5	14.0	26.5
W371PLP-10M-6R	10	3/8	17	40.5	14.0	26.5
W371PLP-10M-8R	10	1/2	21	40.5	14.0	26.5
W371PLP-12M-4R	12	1/4	15	46.5	15.5	31.0
W371PLP-12M-6R	12	3/8	17	46.5	15.5	31.0
W371PLP-12M-8R	12	1/2	21	46.5	15.5	31.0
W371PLP-14M-6R	14	3/8	20	55.0	19.5	35.5
W371PLP-14M-8R	14	1/2	24	52.5	17.5	35.5

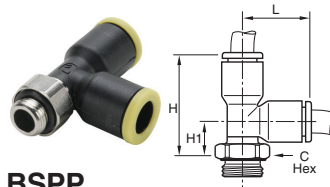

371PLP Male Run Tee - BSPP

PART NO.	TUBE SIZE (MM)	BSPP / M5	C HEX (MM)	H	H1	L
371PLP-4M-M5	4	M5X0.8	8	26.0	11.5	14.5
371PLP-4M-2G	4	1/8	13	23.0	8.5	14.5
371PLP-4M-4G	4	1/4	16	23.0	8.5	14.5
371PLP-6M-M5	6	M5X0.8	8	29.5	12.5	17.5
371PLP-6M-2G	6	1/8	13	27.0	10.0	17.5
371PLP-6M-4G	6	1/4	16	27.0	10.0	17.5
371PLP-8M-2G	8	1/8	13	36.5	14.0	23.0
371PLP-8M-4G	8	1/4	16	34.5	12.0	23.0
371PLP-8M-6G	8	3/8	20	34.5	12.0	23.0
371PLP-10M-4G	10	1/4	16	42.0	15.5	26.5
371PLP-10M-6G	10	3/8	20	40.5	14.0	26.5
371PLP-10M-8G	10	1/2	24	40.5	14.0	26.5
371PLP-12M-4G	12	1/4	16	48.0	17.0	31.0
371PLP-12M-6G	12	3/8	20	46.5	15.5	31.0
371PLP-12M-8G	12	1/2	24	46.5	15.5	31.0
371PLP-14M-6G	14	3/8	20	56.5	21.5	35.5
371PLP-14M-8G	14	1/2	24	51.0	16.0	35.5

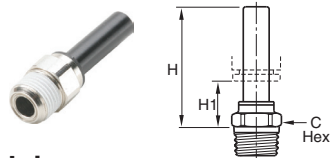

W68PLPSP Male Standpipe

PART NO.	TUBE SIZE (IN)	THREAD NPT / UNF	C HEX (MM)	H	H1
68PLPSP-5/32-0	5/32	10-32	8	1.24	
W68PLPSP-5/32-2	5/32	1/8	11	1.02	0.57
W68PLPSP-5/32-4	5/32	1/4	14	1.04	0.59
W68PLPSP-4-2	1/4	1/8	11	1.18	0.61
W68PLPSP-4-4	1/4	1/4	14	1.12	0.57
W68PLPSP-5-2	5/16	1/8	11	1.16	0.43
W68PLPSP-5-4	5/16	1/4	14	1.12	0.39
W68PLPSP-6-2	3/8	1/8	15	1.75	0.65
W68PLPSP-6-4	3/8	1/4	15	1.42	0.67
W68PLPSP-6-6	3/8	3/8	17	1.42	0.61
W68PLPSP-8-6	1/2	3/8	17	1.44	0.37
W68PLPSP-8-8	1/2	1/2	21	1.46	0.39

W68PLPSP Male Standpipe - BSPT

PART NO.	TUBE SIZE (MM)	BSPT	C HEX (MM)	H	H1
W68PLPSP-4M-2R	4	1/8	10	26.0	14.0
W68PLPSP-4M-4R	4	1/4	14	26.5	14.5
W68PLPSP-6M-2R	6	1/8	10	28.0	14.0
W68PLPSP-6M-4R	6	1/4	14	28.5	14.5
W68PLPSP-8M-2R	8	1/8	10	29.5	11.0
W68PLPSP-8M-4R	8	1/4	14	28.5	10.0
W68PLPSP-8M-6R	8	3/8	17	28.5	10.0
W68PLPSP-10M-4R	10	1/4	15	36.0	15.5
W68PLPSP-10M-6R	10	3/8	17	36.0	15.5
W68PLPSP-10M-8R	10	1/2	21	36.0	15.5
W68PLPSP-12M-6R	12	3/8	17	36.5	12.0
W68PLPSP-12M-8R	12	1/2	21	36.5	12.0
W68PLPSP-14M-8R	14	1/2	21	41.0	13.5

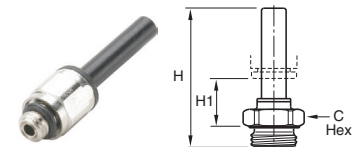

68PLPSP Male Standpipe - BSPP

PART NO.	TUBE SIZE (MM)	BSPT	C HEX (MM)	H	H1
68PLPSP-4M-M5	4	M5X0.8	8	31.0	16.0
68PLPSP-4M-2G	4	1/8	13	30.0	13.5
68PLPSP-4M-4G	4	1/4	16	31.0	13.5
68PLPSP-6M-2G	6	1/8	13	32.0	13.5
68PLPSP-6M-4G	6	1/4	16	33.0	13.5
68PLPSP-8M-2G	8	1/8	13	35.5	12.5
68PLPSP-8M-4G	8	1/4	16	34.5	10.5
68PLPSP-8M-6G	8	3/8	20	34.5	10.5
68PLPSP-10M-4G	10	1/4	16	43.5	17.5
68PLPSP-10M-6G	10	3/8	20	41.5	15.5
68PLPSP-10M-8G	10	1/2	24	41.5	15.5
68PLPSP-12M-6G	12	3/8	20	42.0	12.0
68PLPSP-12M-8G	12	1/2	24	43.5	12.0
68PLPSP-14M-6G	14	3/8	20	46.5	14.0
68PLPSP-14M-8G	14	1/2	24	48.0	13.5

B

B

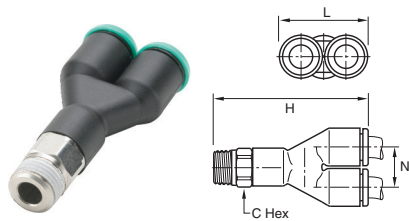

W368PLP Male Y Connector

PART NO.	TUBE SIZE (IN)	THREAD NPT	C HEX (MM)	H	L	N
W368PLP-5/32-2	5/32	1/8	11	1.28	0.69	0.35
W368PLP-5/32-4	5/32	1/4	14	1.30	0.69	0.35
W368PLP-4-2	1/4	1/8	11	1.61	0.87	0.45
W368PLP-4-4	1/4	1/4	14	1.56	0.87	0.45
W368PLP-6-4	3/8	1/4	17	2.24	1.30	0.67
W368PLP-6-6	3/8	3/8	18	2.28	1.30	0.67

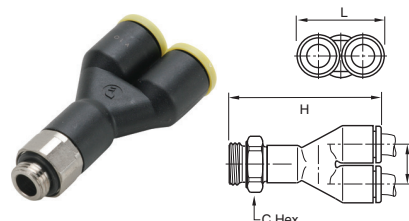

368PLP Male Y Connector - BSPP

PART NO.	TUBE SIZE (MM)	BSPP / M5	C HEX (MM)	H	L	N
368PLP-4M-M5	4	M5X0.8	8	32.5	17.5	9.0
368PLP-4M-2G	4	1/8	13	32.0	17.5	9.0
368PLP-4M-4G	4	1/4	16	32.0	17.5	9.0
368PLP-6M-M5	6	M5X0.8	10	39.5	21.5	11.0
368PLP-6M-2G	6	1/8	13	39.0	21.5	11.0
368PLP-6M-4G	6	1/4	16	39.0	21.5	11.0
368PLP-8M-2G	8	1/8	13	56.0	28.0	14.5
368PLP-8M-4G	8	1/4	16	55.0	28.0	14.5
368PLP-8M-6G	8	3/8	19	54.0	28.0	14.5
368PLP-10M-4G	10	1/4	16	63.5	33.0	17.0
368PLP-10M-6G	10	3/8	20	63.5	33.0	17.0
368PLP-10M-8G	10	1/2	20	65.0	33.0	17.0
368PLP-12M-6G	12	3/8	19	68.0	39.0	20.0
368PLP-12M-8G	12	1/2	24	70.0	39.0	20.0

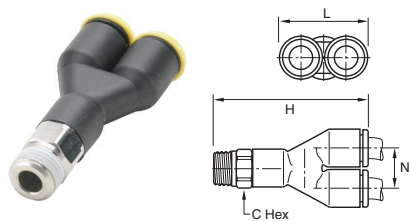

W368PLP Male Y Connector - BSPT

PART NO.	TUBE SIZE (MM)	BSPT	C HEX (MM)	H	L	N
W368PLP-4M-2R	4	1/8	10	32.5	17.5	9.0
W368PLP-4M-4R	4	1/4	14	33.0	17.5	9.0
W368PLP-6M-2R	6	1/8	10	39.5	21.5	1.0
W368PLP-6M-4R	6	1/4	14	40.0	21.5	1.0
W368PLP-8M-2R	8	1/8	13	56.5	28.0	14.5
W368PLP-8M-4R	8	1/4	14	55.5	28.0	14.5
W368PLP-8M-6R	8	3/8	16	48.5	28.0	14.5
W368PLP-10M-4R	10	1/4	14	60.0	39.0	20.0
W368PLP-10M-6R	10	3/8	16	60.5	39.0	20.0
W368PLP-10M-8R	10	1/2	24	61.0	39.0	20.0
W368PLP-12M-6R	12	3/8	19	66.0	39.0	20.0
W368PLP-12M-8R	12	1/2	21	66.0	39.0	20.0

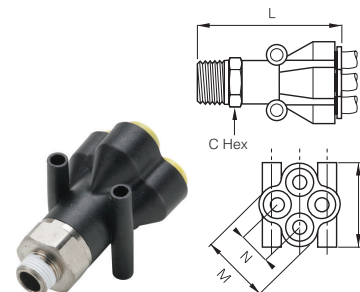

W368PLPD Double Y Male Connector - BSPT

PART NO.	TUBE SIZE (MM)	BSPT	C HEX (MM)	H	L	M	N	MOUNTING HOLE DIA
W368PLPD-4M-2R	4	1/8	13	25.5	41.5	21.0	10.0	3.7
W368PLPD-4M-4R	4	1/4	14	25.5	43.5	21.0	10.0	3.7
W368PLPD-6M-2R	6	1/8	19	31.5	54.5	26.5	12.0	3.7
W368PLPD-6M-4R	6	1/4	19	31.5	57.5	26.5	12.0	3.7

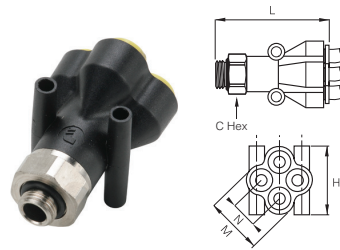

368PLPD Double Y Male Connector - BSPP

PART NO.	TUBE SIZE (MM)	BSPP	C HEX (MM)	H	L	M	N	MOUNTING HOLE DIA
368PLPD-4M-2G	4	1/8	13	25.5	41.0	21.0	10.0	3.7
368PLPD-4M-4G	4	1/4	16	25.5	40.0	21.0	10.0	3.7
368PLPD-6M-2G	6	1/8	19	31.5	52.5	26.5	12.0	3.7
368PLPD-6M-4G	6	1/4	19	31.5	53.5	26.5	12.0	3.7

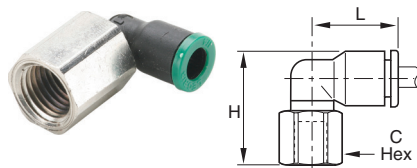

370PLP Female Elbow Swivel

PART NO.	TUBE SIZE (IN)	THREAD NPT	C HEX (MM)	L	H
370PLP-2-2	1/8	1/8	13	0.57	0.91
370PLP-5/32-2	5/32	1/8	13	0.55	0.91
370PLP-5/32-4	5/32	1/4	16	0.55	1.08
370PLP-4-2	1/4	1/8	13	0.71	1.02
370PLP-4-4	1/4	1/4	16	0.71	1.18
370PLP-5-2	5/16	1/8	13	0.91	1.12
370PLP-5-4	5/16	1/4	16	0.91	1.28
370PLP-6-4	3/8	1/4	16	1.04	1.52
370PLP-8-6	1/2	3/8	22	1.38	1.88

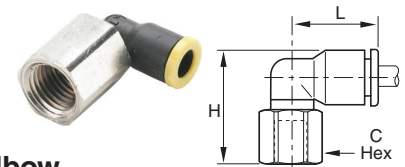

370PLP Female Elbow

PART NO.	TUBE SIZE (MM)	BSPP	C HEX (MM)	H	L
370PLP-4M-2G	4	1/8	13	23.0	14.0
370PLP-4M-4G	4	1/4	16	27.0	14.0
370PLP-6M-2G	6	1/8	13	25.0	16.0
370PLP-6M-4G	6	1/4	16	29.0	16.0
370PLP-8M-2G	8	1/8	13	28.0	23.0
370PLP-8M-4G	8	1/4	16	32.0	23.0
370PLP-8M-6G	8	3/8	19	33.0	23.0
370PLP-10M-4G	10	1/4	16	34.5	26.5
370PLP-10M-6G	10	3/8	19	35.0	26.5
370PLP-10M-8G	10	1/2	24	41.0	26.5
370PLP-12M-4G	12	1/4	16	38.0	30.5
370PLP-12M-6G	12	3/8	19	38.5	30.5
370PLP-12M-8G	12	1/2	24	43.5	30.5

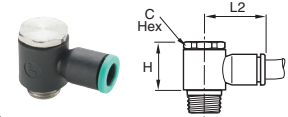

W369PLPBJ Single Banjo

PART NO.	TUBE SIZE (IN)	THREAD NPT / UNF	C HEX (MM)	H	L2
369PLPBJ-2-0	1/8	10-32		0.79	0.65
369PLPBJ-5/32-0	5/32	10-32		0.79	0.65
W369PLPBJ-5/32-2	5/32	1/8	13	0.73	0.73
369PLPBJ-4-0	1/4	10-32		0.79	0.73
W369PLPBJ-4-2	1/4	1/8	13	0.73	0.83
W369PLPBJ-4-4	1/4	1/4	17	0.89	0.91
W369PLPBJ-4-6	1/4	3/8	21	1.04	1.12
W369PLPBJ-6-4	3/8	1/4	17	0.89	1.12
W369PLPBJ-6-6	3/8	3/8	21	1.04	1.20

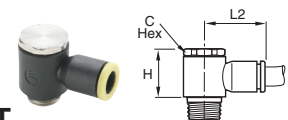

W369PLPBJ Banjo - BSPT

PART NO.	TUBE SIZE (MM)	BSPT	C HEX (MM)	H	L2
W369PLPBJ-4M-2R	4	1/8	13	18.5	18.5
W369PLPBJ-6M-2R	6	1/8	13	18.5	20.0
W369PLPBJ-6M-4R	6	1/4	17	22.5	22.0
W369PLPBJ-8M-2R	8	1/8	13	18.5	25.0
W369PLPBJ-8M-4R	8	1/4	17	22.5	27.0
W369PLPBJ-8M-6R	8	3/8	21	26.5	29.0
W369PLPBJ10M-4R	10	1/4	17	22.5	29.0
W369PLPBJ10M-6R	10	3/8	21	26.5	31.0
W369PLPBJ12M-4R	12	1/4	21	26.5	34.5
W369PLPBJ12M-6R	12	3/8	21	26.5	34.5
W369PLPBJ12M-8R	12	1/2	25	30.0	37.0

B

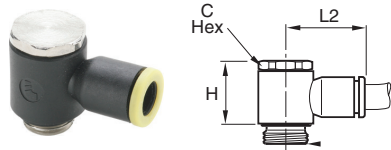

369PLPBJ Banjo - BSPP

PART NO.	TUBE SIZE (MM)	BSPP / METRIC	C HEX (MM)	H	L2
369PLPBJ-3M-M3	3	M3X0.5		13.0	16.0
369PLPBJ-3M-M5	3	M5X0.8		13.0	16.0
369PLPBJ-4M-M5	4	M5X0.8		13.0	16.0
369PLPBJ-4M-2G	4	1/8	13	17.0	18.5
369PLPBJ-6M-M5	6	M5X0.8		13.0	18.5
369PLPBJ-6M-2G	6	1/8	13	17.0	20.0
369PLPBJ-6M-4G	6	1/4	17	21.0	22.0
369PLPBJ-8M-2G	8	1/8	13	16.5	25.0
369PLPBJ-8M-4G	8	1/4	17	21.0	27.0
369PLPBJ-8M-6G	8	3/8	20	24.5	29.0
369PLPBJ-10M-4G	10	1/4	17	21.0	29.0
369PLPBJ-10M-6G	10	3/8	20	24.5	31.0
369PLPBJ-10M-8G	10	1/2	25	27.5	36.5
369PLPBJ-12M-6G	12	3/8	20	24.5	34.5
369PLPBJ-12M-8G	12	1/2	25	27.5	36.5

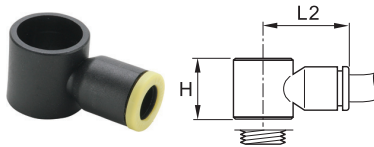

369PLPBJB Single Banjo Bodies

PART NO.	TUBE SIZE (MM)	BSPP / M5	H	L2
369PLPBJB-3M-M5	3	M5X0.8	13.0	16.0
369PLPBJB-4M-M5	4	M5X0.8	13.0	16.0
369PLPBJB-4M-2G	4	1/8	14.5	18.5
369PLPBJB-6M-M5	6	M5X0.8	13.0	18.5
369PLPBJB-6M-2G	6	1/8	14.5	20.0
369PLPBJB-6M-4G	6	1/4	18.0	22.0
369PLPBJB-8M-2G	8	1/8	14.5	25.0
369PLPBJB-8M-4G	8	1/4	18.0	27.0
369PLPBJB-8M-6G	8	3/8	21.5	29.0
369PLPBJB10M-4G	10	1/4	18.0	29.0
369PLPBJB10M-6G	10	3/8	21.5	31.0
369PLPBJB10M-8G	10	1/2	22.5	36.5
369PLPBJB12M-6G	12	3/8	21.5	34.5
369PLPBJB12M-8G	12	1/2	22.5	36.5

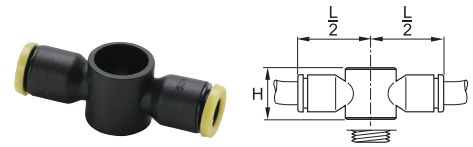

32PLPDJB Double Banjo Bodies

PART NO.	TUBE SIZE (MM)	BSPP / M5	H	L/2
32PLPDJB-4M-M5	4	M5X0.8	13.0	16.0
32PLPDJB-4M-2G	4	1/8	14.4	20.0
32PLPDJB-6M-2G	6	1/8	14.4	20.0
32PLPDJB-6M-4G	6	1/4	18.0	26.0
32PLPDJB-8M-4G	8	1/4	18.0	27.0
32PLPDJB-8M-6G	8	3/8	21.5	30.5
32PLPDJB-10M-6G	10	3/8	21.5	31.0

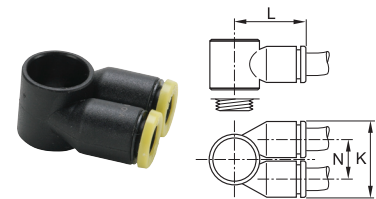

369PLTJB Twin Banjo Bodies

PART NO.	TUBE SIZE (MM)	BSPP / M5	K	L	N
369PLTJB-4M-M5	4	M5X0.8	17.5	15.5	9.0
369PLTJB-4M-2G	4	1/8	22.5	20.0	12.0
369PLTJB-4M-4G	4	1/4	28.0	25.0	14.5
369PLTJB-6M-2G	6	1/8	22.5	20.5	12.0
369PLTJB-6M-4G	6	1/4	28.0	25.0	14.5
369PLTJB-6M-6G	6	3/8	33.0	28.5	17.0
369PLTJB-8M-4G	8	1/4	28.0	26.0	14.5
369PLTJB-8M-6G	8	3/8	33.0	29.5	17.0
369PLTJB10M-6G	10	3/8	33.0	29.5	17.0

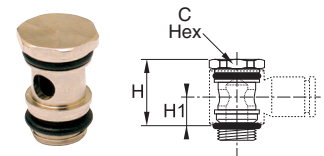

68BJB Single Banjo Bolt

PART NO.	BSPP / M5	C HEX (MM)	H	H1
68BJB-M5	M5X0.8		17.0	7.5
68BJB-2G	1/8	13	17.0	7.5
68BJB-4G	1/4	17	21.0	9.5
68BJB-6G	3/8	20	24.5	11.0
68BJB-8G	1/2	25	27.5	11.5

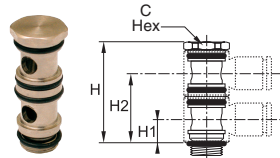

68BJBD Double Banjo Bolt

PART NO.	BSPP / M5	C HEX (MM)	H	H1	H2
68BJBD-M5	M5X0.8		24.5	7.5	18.5
68BJBD-2G	1/8	13	31.0	7.5	22.0
68BJBD-4G	1/4	17	39.0	9.5	27.5
68BJBD-6G	3/8	20	46.0	11.0	32.5

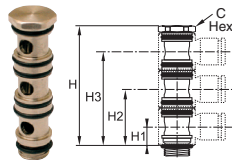

68BJBT Triple Banjo Bolt

PART NO.	BSPP	C HEX (MM)	H	H1	H2	H3
68BJBT-2G	1/8	13	45.5	7.5	22.0	36.0
68BJBT-4G	1/4	17	54.0	9.5	27.5	45.5
68BJBT-6G	3/8	20	67.5	11.0	32.5	54.0

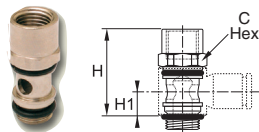

66BJB Female Threaded Banjo Bolt

PART NO.	1 BSPP / M5	2 BSPP / M5	C HEX (MM)	H	H1
66BJB-M5	M5X0.8	M5X0.8	8	17.0	7.5
66BJB-2G	1/8	1/8	13	24.5	7.5
66BJB-4G	1/4	1/4	17	33.0	9.5
66BJB-6G	3/8	3/8	20	37.5	11.0
66BJB-8G	1/2	1/2	25	42.0	11.5

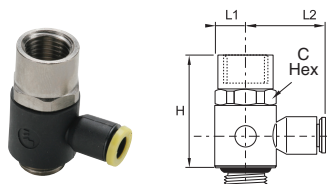

376PLPBJ Banjo with Female Bolt

PART NO.	TUBE SIZE (MM)	BSPP / M5	C HEX (MM)	H	L1	L2
376PLPBJ-4M-M5	4	M5X0.8	8	19.0	5.0	16.0
376PLPBJ-4M-2G	4	1/8	13	25.5	7.0	18.5
376PLPBJ-6M-4G	6	1/4	17	33.0	9.0	22.0

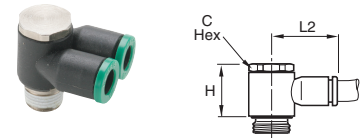

W369PLPTJ Twin Banjo

PART NO.	TUBE SIZE (IN)	THREAD NPT / UNF	C HEX (MM)	H	L2
369PLPTJ-5/32-0	5/32	10-32		0.63	0.61
W369PLPTJ-5/32-2	5/32	1/8	13	0.73	0.73
W369PLPTJ-4-2	1/4	1/8	13	0.73	0.73
W369PLPTJ-4-4	1/4	1/4	17	0.89	1.04
W369PLPTJ-6-4	3/8	1/4	21	1.04	1.22
W369PLPTJ-6-6	3/8	3/8	21	1.04	1.22

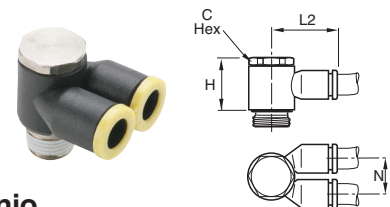

369PLPTJ Twin Banjo

PART NO.	TUBE SIZE (MM)	BSPP / M5	C HEX (MM)	H	L2	N
369PLPTJ-4M-M5	4	M5X0.8		13.0	16.0	9.0
369PLPTJ-4M-2G	4	1/8	13	16.5	18.5	11.5
369PLPTJ-6M-2G	6	1/8	13	16.5	18.5	11.5
369PLPTJ-6M-4G	6	1/4	17	21.0	27.0	14.5
369PLPTJ-8M-4G	8	1/4	17	21.0	27.0	14.5
369PLPTJ-8M-6G	8	3/8	20	24.5	31.0	17.0
369PLPTJ-10M-6G	10	3/8	20	24.5	31.0	17.0

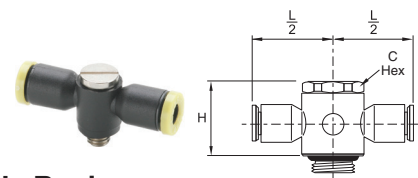

32PLPDJ Double Banjo

PART NO.	TUBE SIZE (MM)	BSPP / M5	C HEX (MM)	H	L/2
32PLPDJ-4M-M5	4	M5X0.8		13.0	16.0
32PLPDJ-6M-2G	6	1/8	13	17.0	20.0
32PLPDJ-6M-4G	6	1/4	17	21.0	26.5
32PLPDJ-8M-4G	8	1/4	17	21.0	27.0
32PLPDJ-8M-6G	8	3/8	20	24.5	30.5
32PLPDJ-10M-6G	10	3/8	20	24.5	31.0

B

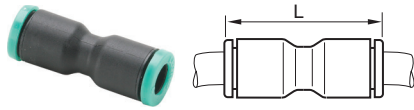

32PLP Equal Union

PART NO.	TUBE SIZE (IN)	L
32PLP-2	1/8	0.97
32PLP-5/32	5/32	0.98
32PLP-3	3/16	1.44
32PLP-4	1/4	1.16
32PLP-5	5/16	1.50
32PLP-6	3/8	1.65
32PLP-8	1/2	2.17

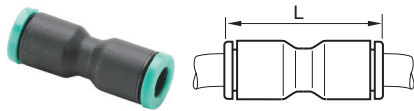

32PLP Unequal Union

PART NO.	1 TUBE SIZE (IN)	2 TUBE SIZE (IN)	L
32PLP-5/32-2	5/32	1/8	0.96
32PLP-5/32-4	5/32	1/4	1.16
32PLP-4-2	1/4	1/8	1.32
32PLP-5-4	5/16	1/4	1.44
32PLP-6-4	3/8	1/4	1.61
32PLP-6-8	3/8	1/2	2.17

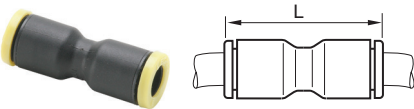

32PLP Union

PART NO.	TUBE SIZE (MM)	L
32PLP-3M	3	25.0
32PLP-4M	4	25.0
32PLP-6M	6	28.5
32PLP-8M	8	38.0
32PLP-10M	10	42.0
32PLP-12M	12	50.5
32PLP-14M	14	56.0

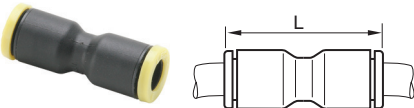

32PLP Unequal Union

PART NO.	1 TUBE SIZE (MM)	2 TUBE SIZE (MM)	L
32PLP-3M-4M	3	4	25.0
32PLP-6M-4M	6	4	28.0
32PLP-8M-4M	8	4	28.0
32PLP-8M-6M	8	6	38.0
32PLP-10M-6M	10	6	42.0
32PLP-10M-8M	10	8	42.0
32PLP-12M-10M	12	10	50.5
32PLP-12M-14M	12	14	56.0
32PLP-12M-8M	12	8	50.5

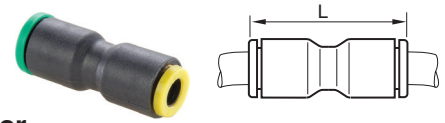

32PLP Converter

PART NO.	TUBE SIZE (IN)	TUBE SIZE (MM)	L
32PLP-6M-4	1/4	6	1.18
32PLP-10M-6	3/8	10	1.99
32PLP-12M-8	1/2	12	2.25

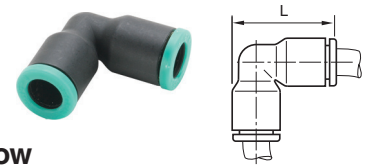

365PLP Union Elbow

PART NO.	TUBE SIZE (IN)	L
365PLP-2	1/8	0.71
365PLP-5/32	5/32	0.75
365PLP-3	3/16	1.07
365PLP-4	1/4	0.93
365PLP-5	5/16	1.16
365PLP-6	3/8	1.33
365PLP-8	1/2	1.38

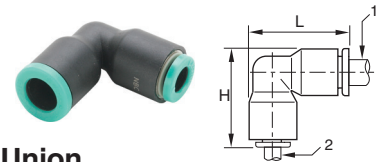

365PLP Unequal Union

PART NO.	1 TUBE SIZE (IN)	2 TUBE SIZE (IN)	L	H
365PLP-2-4	1/8	1/4	0.93	0.93
365PLP-5/32-4	5/32	1/4	0.93	0.93
365PLP-6-4	3/8	1/4	1.33	1.30
365PLP-6-8	3/8	1/2	1.81	1.81

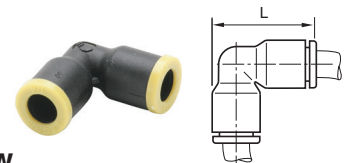

365PLP Union Elbow

PART NO.	TUBE SIZE (MM)	L
365PLP-4M	4	19.0
365PLP-6M	6	22.5
365PLP-8M	8	29.5
365PLP-10M	10	34.5
365PLP-12M	12	40.5
365PLP-14M	14	46.5

B



365PLP Unequal Union Elbow

PART NO.	1 TUBE SIZE (MM)	2 TUBE SIZE (MM)	L
365PLP-4M-6M	4	6	22.5
365PLP-6M-8M	6	8	29.5
365PLP-8M-10M	8	10	34.5
365PLP-10M-12M	10	12	40.5

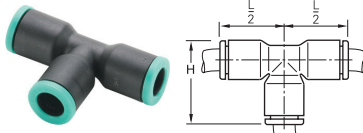

364PLP Union Tee

PART NO.	TUBE SIZE (IN)	L/2	H
364PLP-2	1/8	0.57	0.75
364PLP-5/32	5/32	0.57	0.75
364PLP-3	3/16	0.85	1.07
364PLP-4	1/4	0.93	0.89
364PLP-5	5/16	0.91	1.16
364PLP-6	3/8	1.02	1.34
364PLP-8	1/2	1.38	1.81

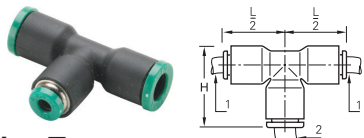

364PLP Unequal Union Tee

PART NO.	1 TUBE SIZE (IN)	2 TUBE SIZE (IN)	L/2	H
364PLP-2-4	1/8	1/4	0.71	0.93
364PLP-5/32-4	5/32	1/4	0.71	0.93
364PLP-4-2	1/4	1/8	0.73	0.93
364PLP-4-5/32	1/4	5/32	0.73	0.93
364PLP-4-6	1/4	3/8	0.96	1.32
364PLP-6-4	3/8	1/4	1.00	1.28
364PLP-6-8	3/8	1/2	1.38	1.81
364PLP-8-4	1/2	1/4	1.38	1.81
364PLP-8-6	1/2	3/8	1.38	1.81

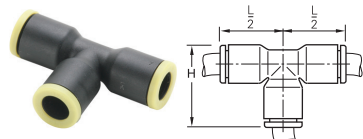

364PLP Union Tee

PART NO.	TUBE SIZE (MM)	H	L/2
364PLP-3M	3	19.0	14.5
364PLP-4M	4	19.0	14.5
364PLP-6M	6	23.5	18.0
364PLP-8M	8	29.5	23.0
364PLP-10M	10	34.5	26.5
364PLP-12M	12	40.5	31.0
364PLP-14M	14	46.0	35.5

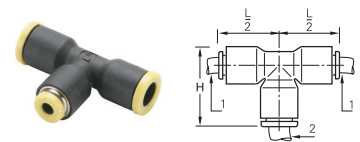

364PLP Unequal Union Tee

PART NO.	1 TUBE SIZE (MM)	2 TUBE SIZE (MM)	H	L/2
364PLP-4M-6M	4	6	22.5	17.5
364PLP-6M-4M	6	4	22.5	17.5
364PLP-6M-8M	6	8	29.5	23.0
364PLP-8M-6M	8	6	29.5	23.0
364PLP-8M-10M	8	10	34.5	26.5
364PLP-10M-12M	10	12	34.5	26.5
364PLP-10M-8M	10	8	40.5	31.0
364PLP-12M-10M	12	10	40.5	31.0
364PLP-14M-8M	14	8	46.0	35.5

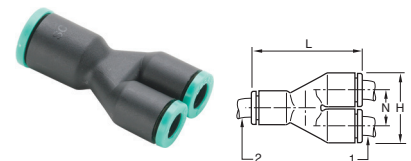

362PLP Union Y Connector

PART NO.	1 TUBE SIZE (IN)	2 TUBE SIZE (IN)	L	H	N
362PLP-2	1/8	1/8	1.12	0.69	0.35
362PLP-2-4	1/8	1/4	1.42	0.87	0.45
362PLP-5/32	5/32	5/32	1.12	0.69	0.35
362PLP-5/32-4	5/32	1/4	1.42	0.87	0.45
362PLP-4	1/4	1/4	1.42	0.87	0.45
362PLP-4-6	1/4	3/8	1.31	1.30	0.67
362PLP-5	5/16	5/16	1.77	1.10	0.57
362PLP-6	3/8	3/8	2.09	1.30	0.67

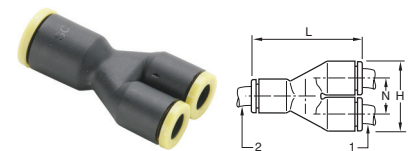

362PLP Union Y Connector

PART NO.	1 TUBE SIZE (MM)	2 TUBE SIZE (M)	H	L	N
362PLP-4M	4	4	17.5	28.5	9.0
362PLP-6M	6	6	21.5	35.0	11.0
362PLP-8M	8	8	28.0	45.0	14.5
362PLP-10M	10	10	33.0	53.0	17.0
362PLP-12M	12	12	39.0	57.0	20.0
362PLP-4M-6M	4	6	17.5	33.0	9.0
362PLP-6M-8M	6	8	22.5	41.0	11.5
362PLP-8M-10M	8	10	28.0	47.0	14.5
362PLP-10M-12M	10	12	33.0	57.0	17.0



B

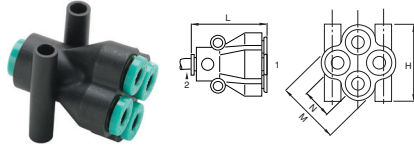

362PLPD Double Y Connector

PART NO.	1 TUBE SIZE (IN)	2 TUBE SIZE (IN)	H	L	M	N	MOUNTING HOLE DIA.
362PLPD-5/32	5/32	5/32	1.00	1.20	0.83	0.39	0.15
362PLPD-5/32-4	5/32	1/4	1.00	1.18	0.83	0.39	0.15

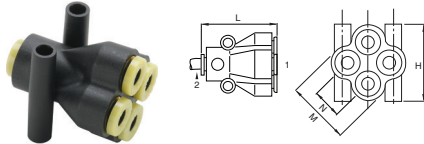

362PLPD Double Y Connector

PART NO.	1 TUBE SIZE (MM)	2 TUBE SIZE (MM)	H	L	M	N	MOUNTING HOLE DIA.
362PLPD-4M	4	4	25.5	30.5	21.0	10.0	3.7
362PLPD-6M	6	6	31.5	37.5	26.5	12.0	3.7
362PLPD-4M-6M	4	6	25.5	30.5	21.0	10.0	3.7
362PLPD-6M-8M	6	8	31.5	38.0	26.5	12.0	3.7

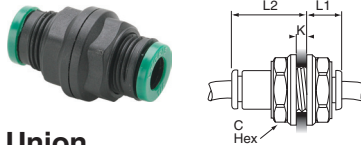

32PLPBH Bulkhead Union

PART NO.	TUBE SIZE (IN)	C HEX (MM)	K MAX	L1	L2
32PLPBH-2	1/8	13	0.22	0.37	0.61
32PLPBH-5/32	5/32	13	0.22	0.59	0.39
32PLPBH-4	1/4	16	0.35	0.37	0.81
32PLPBH-5	5/16	18	0.57	0.98	0.53
32PLPBH-6	3/8	22	0.57	0.51	1.18
32PLPBH-8	1/2	29	0.81	0.67	1.61

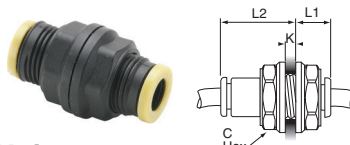

32PLPBH Bulkhead Union

PART NO.	TUBE SIZE (MM)	C HEX (MM)	K MAX	L1	L2
32PLPBH-4M	4	13	5.5	15.0	10.0
32PLPBH-6M	6	15	8.5	18.0	10.5
32PLPBH-8M	8	18	14.5	25.0	13.5
32PLPBH-10M	10	22	14.5	27.5	15.5
32PLPBH-12M	12	26	18.5	33.0	18.0
32PLPBH-14M	14	29	20.5	37.5	20.5

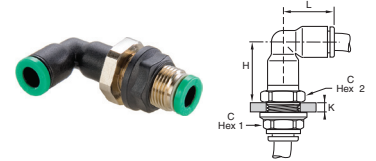

365PLPBH Equal Bulkhead Elbow

PART NO.	TUBE SIZE (IN)	C1 HEX	C2 HEX	K MAX	H	L
365PLPBH-2	1/8	13	13	0.28	0.71	0.57
365PLPBH-5/32	5/32		13	0.26	0.83	0.67
365PLPBH-4	1/4	18	17	0.32	0.87	0.71
365PLPBH-5	5/16		18	0.31	1.22	0.94
365PLPBH-6	3/8	22	22	0.33	1.08	1.00
365PLPBH-8	1/2	29	27	0.41	1.54	1.38

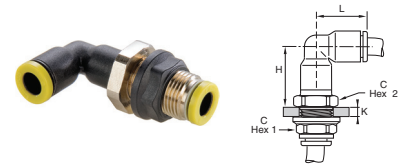

365PLPBH Equal Bulkhead Elbow

PART NO.	TUBE SIZE (MM)	C1 HEX	C2 HEX	K MAX	H	L
365PLPBH-4M	4	13	13	6.5	21.0	17.0
365PLPBH-6M	6	15	15	7.0	24.5	19.5
365PLPBH-8M	8	18	18	8.0	31.0	24.0
365PLPBH-10M	10	22	22	8.5	36.0	28.0
365PLPBH-12M	12	26	26	8.5	42.0	33.0

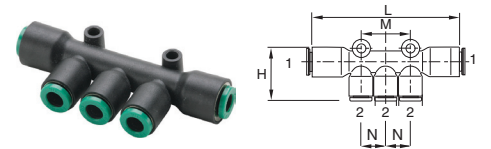

24PLP Multiple Tee

PART NO.	1 TUBE SIZE (IN)	2 TUBE SIZE (IN)	H	L	M	N	MOUNTING HOLE DIA.
24PLP-4-5/32	1/4	5/32	0.97	2.81	0.90	0.45	0.17
24PLP-4-4	1/4	1/4	1.22	3.14	1.21	0.61	0.17
24PLP-5-5/32	5/16	5/32	0.96	2.91		0.45	0.17
24PLP-6-4	3/8	1/4	1.34	3.21	1.22	0.61	0.17

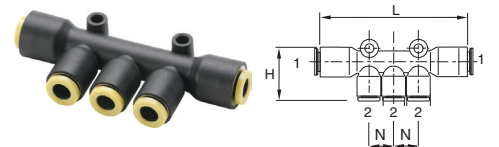

24PLP Multiple Tee

PART NO.	1 TUBE SIZE (MM)	2 TUBE SIZE (M)	H	L	N	MOUNTING HOLE DIA.
24PLP-6M-4M	6	4	24.5	74	11.5	4.2
24PLP-8M-4M	8	4	24.5	74	11.5	4.2
24PLP-8M-6M	8	6	24.5	74	11.5	4.2
24PLP-10M-6M	10	6	36.0	81	14.5	4.2
24PLP-10M-8M	10	8	36.0	81	14.5	4.2

B

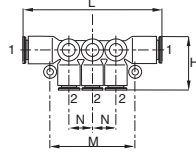

24PLPD Double Multiple Tee

PART NO.	1 TUBE SIZE (IN)	2 TUBE SIZE (IN)	H	L	M	N	MOUNTING HOLE DIA.
24PLPD-4-5/32	1/4	5/32	0.73	2.84	1.69	0.45	0.17
24PLPD-4-4	1/4	1/4	0.73	2.84	1.69	0.45	0.17
24PLPD-5-5/32	5/16	5/32	0.77	2.87	1.69	0.45	0.17
24PLPD-6-4	3/8	1/4	0.91	3.31	2.05	0.57	0.17

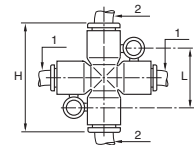

347PLP Unequal Cross

PART NO.	1 TUBE SIZE (MM)	2 TUBE SIZE (MM)	H	L	MOUNTING HOLE DIA.
347PLP-4M-6M	4	6	36	20.0	4.2
347PLP-6M-8M	6	8	46	22.5	4.2
347PLP-4M-6M	4	6	36	20.0	4.2
374PLP-6M-8M	6	8	46	22.5	4.2

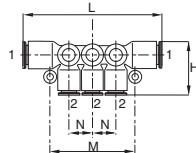

24PLPD Double Multiple Tee

PART NO.	1 TUBE SIZE (MM)	2 TUBE SIZE (MM)	H	L	M	N	MOUNTING HOLE DIA.
24PLPD-6M-4M	6	4	18.5	72.0	43.0	11.5	4.2
24PLPD-8M-4M	8	4	18.5	73.0	43.0	11.5	4.2
24PLPD-8M-6M	8	6	18.5	73.0	43.0	11.5	4.2
24PLPD-10M-6M	10	6	23.0	84.0	52.0	14.5	4.2
24PLPD-10M-8M	10	8	23.5	84.0	52.0	14.5	4.2

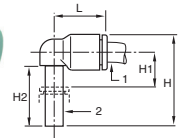

369PLPSP Plug-In Elbow

PART NO.	1 TUBE SIZE (IN)	2 TUBE SIZE (IN)	H	H1	H2	L
369PLPSP-2	1/8	1/8	0.92	0.31	0.64	0.57
369PLPSP-5/32	5/32	5/32	0.91	0.24	0.61	0.55
369PLPSP-5/32-4	5/32	1/4	1.08	0.30	0.71	0.71
369PLPSP-4	1/4	1/4	1.20	0.43	0.83	0.73
369PLPSP-4-6	1/4	3/8	1.52	0.35	0.96	0.98
369PLPSP-5	5/16	5/16	1.32	0.32	0.85	0.91
369PLPSP-6	3/8	3/8	1.52	0.35	0.96	1.02
369PLPSP-8	1/2	1/2	2.00	0.51	1.12	1.38

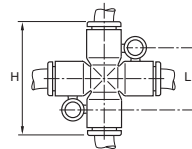

347PLP Equal Cross

PART NO.	TUBE SIZE (IN)	H	L	MOUNTING HOLE DIA.
347PLP-5/32	5/32	1.42	0.79	0.17
347PLP-4	1/4	1.40	0.79	0.17
347PLP-5	5/16	1.81	0.89	0.17

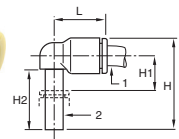

369PLPSP Plug-In Elbow

PART NO.	1 TUBE SIZE (MM)	2 TUBE SIZE (M)	H	H1	H2	L
369PLPSP-4M	4	4	23.0	6.0	15.5	14.0
369PLPSP-6M	6	6	26.5	7.0	17.0	16.0
369PLPSP-8M	8	8	33.5	8.0	21.5	23.0
369PLPSP-10M	10	10	39.0	9.5	24.5	23.5
369PLPSP-12M	12	12	44.5	10.0	27.5	31.0
369PLPSP-4M-6M	4	6	26.5	7.0	17.0	16.0
369PLPSP-6M-4M	6	4	24.5	7.0	15.5	16.0
369PLPSP-6M-8M	6	8	33.5	8.0	21.5	22.0
369PLPSP-8M-10M	8	10	39.0	8.5	24.5	26.5
369PLPSP10M-12M	10	12	44.5	10.0	27.5	31.0

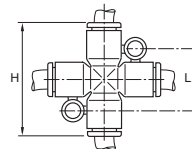

347PLP Equal Cross

PART NO.	TUBE SIZE (MM)	H	L	MOUNTING HOLE DIA.
347PLP-4M	4	36	20.0	4.2
347PLP-6M	6	36	20.0	4.2
347PLP-8M	8	46	22.5	4.2

B

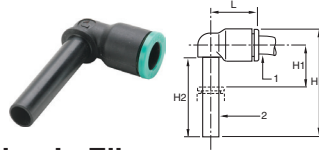

369PLPSPX Extended Plug-In Elbow

PART NO.	1 TUBE SIZE (IN)	2 TUBE SIZE (IN)	H	H1	H2	L
369PLPSPX-2	1/8	1/8	1.26	0.65	0.98	0.57
369PLPSPX-5/32	5/32	5/32	1.28	0.61	0.98	0.55
369PLPSPX-4	1/4	1/4	1.56	0.77	1.18	0.71
369PLPSPX-5	5/16	5/16	1.93	0.93	1.46	0.91
369PLPSPX-6	3/8	3/8	2.19	1.02	1.63	1.02

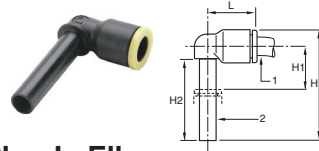

369PLPXSP Extended Plug-In Elbow

PART NO.	1 TUBE SIZE (MM)	2 TUBE SIZE (MM)	H	H1	H2	L
369PLPXSP-4M	4	4	32.5	15.5	25.0	14.0
369PLPXSP-6M	6	6	38.5	19.0	29.0	16.0
369PLPXSP-8M	8	8	49.0	23.5	37.0	23.0
369PLPXSP-10M	10	10	56.0	26.5	41.5	26.5
369PLPXSP-12M	12	12	62.5	28.0	45.5	31.0
369PLPXSP-4M-6M	4	6	38.5	19.0	29.0	16.0
369PLPXSP-6M-8M	6	8	49.0	23.5	37.0	23.0
369PLPXSP-8M10M	8	10	56.0	26.5	41.5	26.5
369PLPXSP-1012M	10	12	62.5	28.0	45.5	31.0

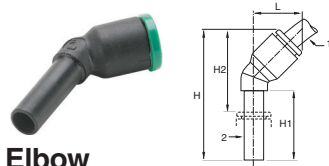

379PLPSP 45° Plug-In Elbow

PART NO.	1 TUBE SIZE (IN)	2 TUBE SIZE (IN)	H	H1	H2	L
379PLPSP-2	1/8	1/8	1.14	0.59	0.69	0.47
379PLPSP-5/32	5/32	5/32	1.32	0.75	0.83	0.51
379PLPSP-4	1/4	1/4	1.44	0.71	0.87	0.57
379PLPSP-5	5/16	5/16	1.73	0.85	1.00	0.77
379PLPSP-6	3/8	3/8	2.00	0.96	1.16	0.91

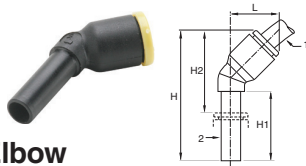

379PLPSP 45° Plug-In Elbow

PART NO.	1 TUBE SIZE (MM)	2 TUBE SIZE (MM)	H	H1	H2	L
379PLPSP-4M	4	4	33.5	19.0	21.0	13.0
379PLPSP-6M	6	6	39.0	21.0	25.0	14.5
379PLPSP-8M	8	8	44.0	21.5	25.5	19.5
379PLPSP-10M	10	10	53.0	27.0	32.5	23.0
379PLPSP-12M	12	12	58.5	27.5	34.0	26.5

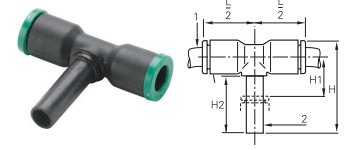

372PLPSP Plug-In Branch Tee

PART NO.	1 TUBE SIZE (IN)	2 TUBE SIZE (IN)	H	H1	H2	L/2
372PLPSP-2	1/8	1/8	0.95	0.26	0.59	0.57
372PLPSP-5/32	5/32	5/32	0.91	0.24	0.61	0.57
372PLPSP-4	1/4	1/4	0.98	0.43	0.77	0.73
372PLPSP-5	5/16	5/16	1.32	0.32	0.85	0.91
372PLPSP-6	3/8	3/8	1.61	0.35	0.96	0.98
372PLPSP-8	1/2	1/2	2.01	0.51	1.12	1.38

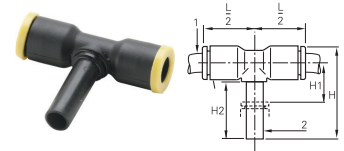

372PLPSP Plug-In Branch Tee

PART NO.	1 TUBE SIZE (MM)	2 TUBE SIZE (M)	H	H1	H2	L/2
372PLPSP-4M	4	4	23.0	6.0	15.5	14.5
372PLPSP-6M	6	6	26.5	7.0	17.0	16.0
372PLPSP-8M	8	8	33.5	8.0	21.5	23.0
372PLPSP-10M	10	10	39.0	9.5	24.5	26.5
372PLPSP-12M	12	12	44.5	10.0	27.5	31.0
372PLPSP-4M-6M	4	6	26.5	7.0	17.0	16.0
372PLPSP-6M-8M	6	8	33.5	8.0	21.5	23.0
372PLPSP-8M-10M	8	10	39.0	9.5	24.5	26.5
372PLPSP10M-12M	10	12	44.5	10.0	27.5	31.0

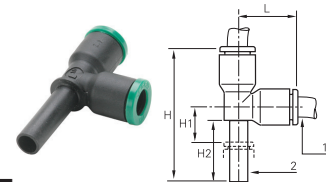

371PLPSP Plug-In Run Tee

PART NO.	1 TUBE SIZE (IN)	2 TUBE SIZE (IN)	H	H1	H2	L
371PLPSP-5/32	5/32	5/32	1.30	0.24	0.61	0.57
371PLPSP-4	1/4	1/4	1.69	0.43	0.83	0.73
371PLPSP-5	5/16	5/16	1.93	0.32	0.85	0.91
371PLPSP-6	3/8	3/8	2.23	0.33	0.96	1.00
371PLPSP-8	1/2	1/2	2.86	0.51	1.12	1.38

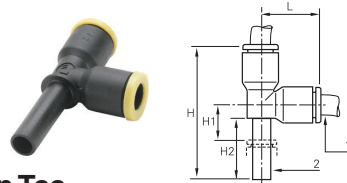

371PLPSP Plug-In Run Tee

PART NO.	1 TUBE SIZE (MM)	2 TUBE SIZE (MM)	H	H1	H2	L
371PLPSP-4M	4	4	33.0	6.0	15.5	14.5
371PLPSP-6M	6	6	38.5	7.0	17.0	17.5
371PLPSP-8M	8	8	49.0	8.0	21.5	23.0
371PLPSP-10M	10	10	57.0	10.5	24.5	26.5
371PLPSP-12M	12	12	65.5	10.5	27.5	31.0
371PLPSP-4M-6M	4	6	10.5	7.0	17.0	17.5
371PLPSP-6M-8M	6	8	13.5	8.0	21.5	23.0
371PLPSP-8M-10M	8	10	16.0	10.5	24.5	26.5
371PLPSP-1012M	10	12	19.0	10.5	27.5	31.0

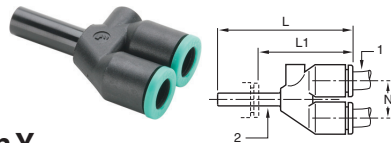

362PLPSP Plug-In Y

PART NO.	1 TUBE SIZE (IN)	2 TUBE SIZE (IN)	L	L1	N
362PLPSP-2	1/8	1/8	1.36	1.00	0.35
362PLPSP-5/32	5/32	5/32	1.34	0.85	0.35
362PLPSP-4	1/4	1/4	1.60	1.02	0.45
362PLPSP-5	5/16	5/16	2.00	1.26	0.57
362PLPSP-6	3/8	3/8	2.23	1.42	0.67

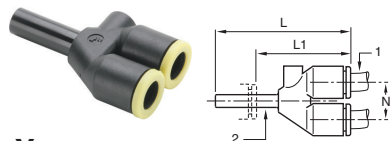

362PLPSP Plug-In Y

PART NO.	1 TUBE SIZE (MM)	2 TUBE SIZE (M)	L	L1	N
362PLPSP-4M	4	4	34.0	21.5	9.0
362PLPSP-6M	6	6	39.5	25.5	11.0
362PLPSP-8M	8	8	50.5	32.0	14.5
362PLPSP-10M	10	10	57.5	36.0	17.0
362PLPSP-12M	12	12	66.0	41.0	20.0
362PLPSP-4M-6M	4	6	35.5	21.5	9.0
362PLPSP-6M-8M	6	8	44.0	25.5	11.0
362PLPSP-8M-10M	8	10	53.5	32.0	14.5
362PLPSP-10M-12M	10	12	60.0	35.0	17.0

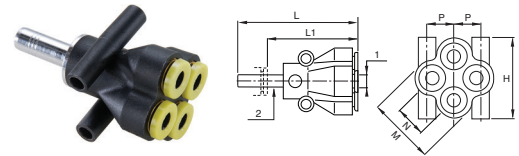

362PLPDSP Plug-In Multiple Y

PART NO.	1 TUBE SIZE (MM)	2 TUBE SIZE (M)	H	L	L1	M	N
362PLPDSP-6M-4M	6	4	25.5	45.0	31.0	21.0	10.0
362PLPDSP-8M-4M	8	4	25.5	49.5	31.0	21.0	10.0
362PLPDSP-8M-6M	8	6	31.5	59.5	41.0	26.5	12.0

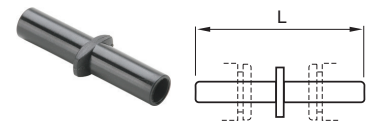

63PLP Double Male Union

PART NO.	TUBE SIZE (IN)	L
63PLP-5/32	5/32	1.36
63PLP-4	1/4	1.52
63PLP-5	5/16	1.61
63PLP-6	3/8	2.03
63PLP-8	1/2	2.13

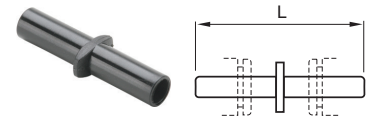

63PLP Double Male Union

PART NO.	TUBE SIZE (MM)	L
63PLP4M	4	34 1/2
63PLP6M	6	38 1/2
63PLP8M	8	41
63PLP10M	10	51 1/2
63PLP12M	12	60
63PLP14M	14	69 1/2

B

B

67PLP Tube End Reducer

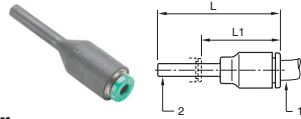

PART NO.	1 TUBE SIZE (IN)	2 TUBE SIZE (IN)	L	L1
67PLP-2-5/32	1/8	5/32	1.79	1.32
67PLP-2-3	1/8	3/16	1.79	1.14
67PLP-2-4	1/8	1/4	1.79	1.22
67PLP-5/32-3	5/32	3/16	1.48	.83
67PLP-5/32-4	5/32	1/4	1.48	.91
67PLP-5/32-5	5/32	5/16	1.48	.75
67PLP-5/32-6	5/32	3/8	1.61	.81
67PLP-3-5	3/16	5/16	1.79	1.06
67PLP-3-4	3/16	1/4	1.79	1.22
67PLP-4-5	1/4	5/16	1.61	.89
67PLP-4-6	1/4	3/8	1.61	.81
67PLP-4-8	1/4	1/2	1.97	.98
67PLP-5-6	5/16	3/8	1.93	1.12
67PLP-5-8	5/16	1/2	2.01	1.02
67PLP-6-8	3/8	1/2	2.01	1.04

32PLPSP Tube Expander

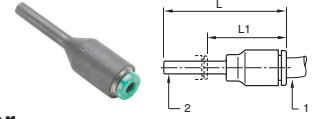

PART NO.	1 TUBE SIZE (IN)	2 TUBE SIZE (IN)	L	L1
32PLPSP-4-2	1/4	1/8	1.61	1.16
32PLPSP-4-6M	1/4	6M	1.75	1.02
32PLPSP-4-5/32	1/4	5/32	1.61	1.14
32PLPSP-4-3	1/4	3/16	1.61	1.00
32PLPSP-6-4	3/8	1/4	1.58	1.00

32PLPSP Tube Expander

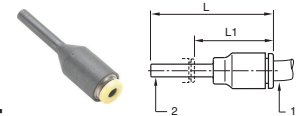

PART NO.	TUBE SIZE (MM)	TUBE SIZE (MM)	L	L1
32PLPSP-6M-4M	6	4	35.0	23.0
32PLPSP-8M-6M	8	6	45.0	31.5
32PLPSP-10M-8M	10	8	42.5	21.0
32PLPSP-12M-10M	12	10	49.0	24.5

67PLP Tube Reducer

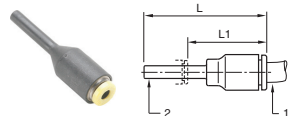

PART NO.	1 TUBE SIZE (MM)	2 TUBE SIZE (MM)	L	L1
67PLP-6M-4M	6	4	37.5	23.5
67PLP-8M-4M	8	4	37.5	19.0
67PLP-8M-6M	8	6	36.0	20.5
67PLP-10M-4M	10	4	44.0	22.5
67PLP-10M-6M	10	6	38.0	17.5
67PLP-10M-8M	10	8	49.0	28.5
67PLP-12M-10M	12	10	56.5	33.5
67PLP-12M-6M	12	6	46.0	23.0
67PLP-12M-8M	12	8	49.0	24.5
67PLP-14M-10M	14	10	58.5	33.5
67PLP-14M-12M	14	12	58.5	33.5
67PLP-14M-6M	14	6	48.0	23.0
67PLP-14M-8M	14	8	48.0	23.0

32PLPSP Tube Converter

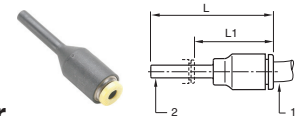

PART NO.	1 TUBE SIZE (MM)	2 TUBE SIZE (IN)	L	L1
32PLPSP-4M-2	4M	1/8	1.61	1.16
32PLPSP-8M-4	8M	1/4	1.58	1.00

639PLP Plug

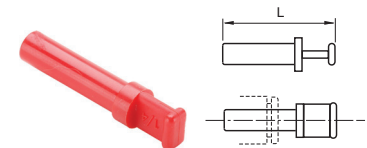

PART NO.	TUBE SIZE (IN)	L
639PLP-2	1/8	1.30
639PLP-5/32	5/32	1.18
639PLP-3	3/16	1.36
639PLP-4	1/4	1.44
639PLP-5	5/16	1.38
639PLP-6	3/8	1.67
639PLP-8	1/2	1.91

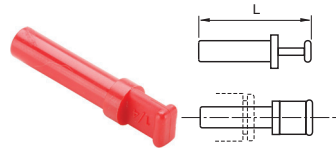

639PLP Plug

PART NO.	TUBE SIZE (MM)	L
639PLP-3M	3	25
639PLP-4M	4	30
639PLP-6M	6	33
639PLP-8M	8	33
639PLP-10M	10	42
639PLP-12M	12	45
639PLP-14M	14	49

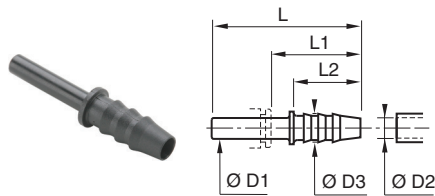

322PLPSP Barbed Connector

PART NO.	OD 1	OD 2	OD 3	L	L1	L2
322PLPSP-2-5/32	5/32	0.12	0.20	1.46	0.98	0.67
322PLPSP5M-5/32	5/32	0.20	0.28	1.46	0.98	0.67
322PLPSP-3-4	1/4	3/16		1.65	1.00	
322PLPSP-4-5	5/16	0.25	0.34	1.55	0.83	0.67
322PLPSP-5-5	3/8	0.32	0.39	1.75	1.02	0.87
322PLPSP-5-6	3/8	0.32	0.39	1.97	1.16	0.87

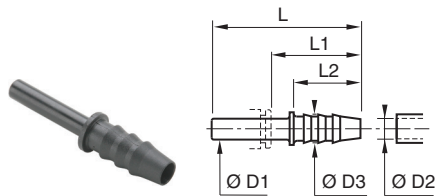

322PLPSP Barbed Connector

PART NO.	OD 1	OD 2	OD 3	L	L1	L2
322PLPSP-3M-4M	4	3.2	5.0	37.0	25.0	17.0
322PLPSP-5M-4M	4	5.0	7.0	37.0	25.0	17.0
322PLPSP-5M-6M	6	5.0	7.0	39.0	25.0	17.0
322PLPSP-6M-8M	8	6.3	8.5	39.5	21.0	17.0
322PLPSP-8M-8M	8	8.0	10.0	44.5	26.0	22.0
322PLPSP-6M-10M	10	6.3	8.0	45.0	24.5	17.0
322PLPSP-8M-10M	10	8.0	10.0	50.0	29.5	22.0
322PLPSP-8M-12M	12	8.0	10.0	50.0	26.0	22.0
322PLPSP-1012M	12	10.0	12.0	48.5	25.5	22.5
322PLPSP-1212M	12	12.5	14.5	57.0	34.0	22.5
322PLPSP-1214M	14	12.5	14.5	59.5	34.5	22.5
322PLPSP-1414M	14	14.0	16.0	59.5	34.5	22.5

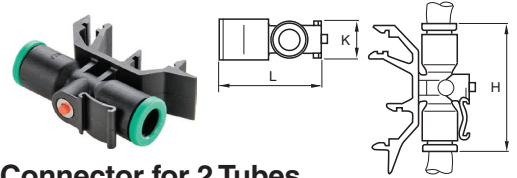

32PLPRC Connector for 2 Tubes

PART NO.	TUBE SIZE (IN)	H	K	L
32PLPRC-5/32	5/32	1.44	0.47	1.18
32PLPRC-4	1/4	1.44	0.47	1.18
32PLPRC-5	5/16	1.81	0.51	1.28

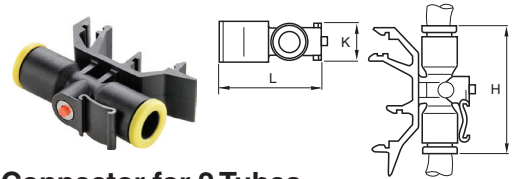

32PLPRC Connector for 2 Tubes

PART NO.	TUBE SIZE (MM)	H	K	L
32PLPRC-4M	4	36.5	11.0	39.5
32PLPRC-6M	6	36.5	11.0	39.5
32PLPRC-8M	8	46.0	13.0	44.5

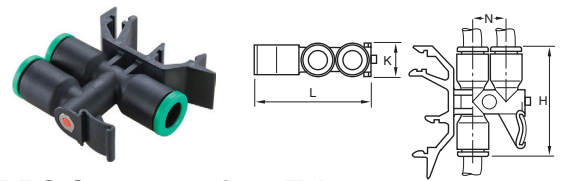

32PLPDRC Connector for 3 Tubes

PART NO.	TUBE SIZE (IN)	H	K	L	N
32PLPDRC-5/32	5/32	1.44	0.43	1.56	0.45
32PLPDRC-5	5/16	1.81	0.51	1.75	0.57

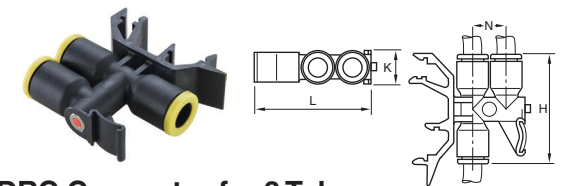

32PLPDRC Connector for 3 Tubes

PART NO.	TUBE SIZE (MM)	H	K	L	N
32PLPDRC-4M	4	36.5	11.0	39.5	
32PLPDRC-6M	6	36.5	11.0	39.5	
32PLPDRC-8M	8	46.0	13.0	14.5	



B

32PLPBHP Plug-in Bulkhead Union

PART NO.	TUBE SIZE (IN)	L1	L2	ØT
32PLPBHP-5/32	5/32	0.26	1.080	0.62
32PLPBHP-4	1/4	0.26	1.240	0.75
32PLPBHP-5	5/16	0.30	1.280	0.87
32PLPBHP-6	3/8	0.30	1.630	1.12
32PLPBHP-8	1/2	0.30	1.710	1.25

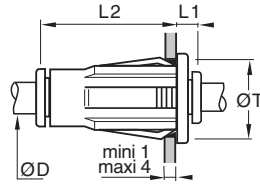

Fixing Hole

D	5/32	1/4	5/16	3/8	1/2
T inches	5/8"	3/4"	7/8"	1 1/8"	1 1/4"
T mm	15.87	19.05	22.22	28.57	31.75
N in	.89	1.00	1.08	1.34	1.50

Tolerance T: +0.3 -0.1

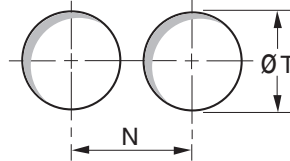

Minimum distance between fittings.
Diameter of fixing hole.

Installation

1. Mark out the fixing hole
2. Make hole in panel
3. Simply push the fitting into place
4. To complete the installation
5. To identify circuits simply remove the black release button and replace with colored one

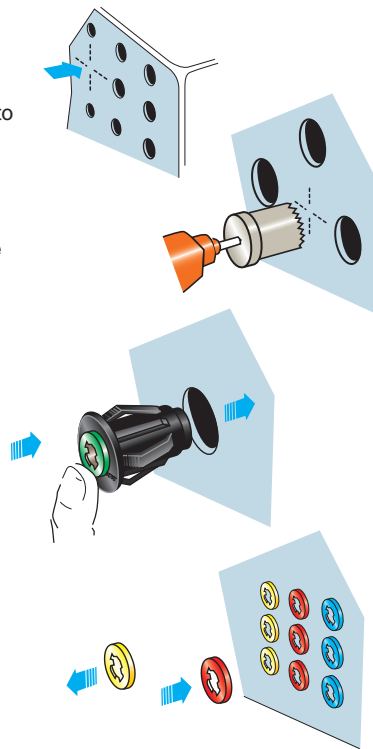

Removal

1. Disconnect the tube
2. Put the removal tool on the fitting
3. Push the tool over the fitting to the bulkhead face
4. Simply remove the fitting

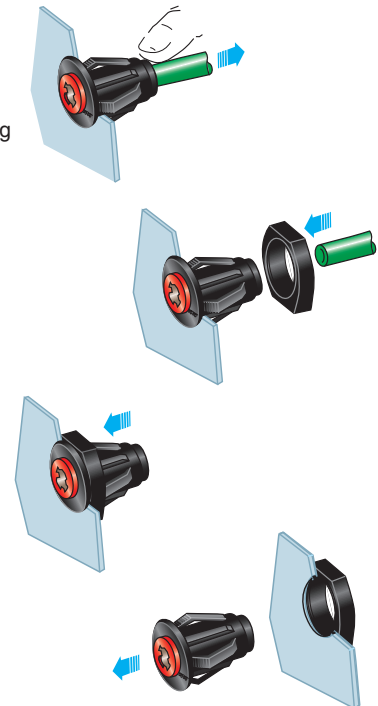



PrestoWeld Fittings

B

MATERIALS OF CONSTRUCTION	
BODY:	NICKEL PLATED BRASS
O-RING:	NITRILE SILICONE FREE
RELEASE BUTTON:	PBT UL94-VO
GRAB RING:	STAINLESS STEEL

NOMENCLATURE	
EXAMPLE: W169PW-4-2	ATTRIBUTE:
W	WHITE PCTFE THREAD SEALANT
169	MALE ELBOW
PW	PRESTOWELD
4	1/4" TUBE O.D.
2	1/8" PIPE THREAD

SPECIFICATIONS	
PRESSURE AND TEMPERATURE RANGE	0° TO +200°F AT UP TO 300 PSI DEPENDING ON TUBING BEING USED
TUBE MATERIAL	PARKER MICROWELD TUBING
TUBE O.D.	1/4, 5/16, 3/8, 1/2
TUBE O.D.(MM)	6, 8, 10, 12



Push-to-connect fittings that are weld splatter resistant and silicone free to meet the requirements of the robotic welding industry. All fittings feature nickel plated brass bodies and threads. The release button collets aids in preventing weld splatter into the fittings.

Assembly Instructions

1. Cut tubing squarely, be certain the port of mating part is clean and free of debris
2. Insert tubing into fitting until it bottoms. A slight twisting motion will ease the insertion. Pull on the tubing to verify it is properly retained in the fitting.
3. To disassemble, simply push in the release button against the body and remove the tubing.
4. It is recommended to trim the tubing after every disassembly to insure a proper seal.



DB Dust/Weld Spatter Boot

PART NO.	TUBE SIZE	L	D
DB-4	1/4	.50	.53
DB-6	3/8	.50	.76
DB-8	1/2	.50	.88

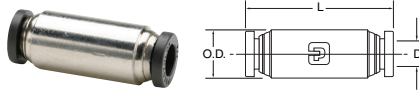

62PW Union (Nickel Plated)

PART NO.	TUBE SIZE	O.D.	L	FLOW DIA. D
62PW-4	1/4	.500	1.43	.188
62PW-5	5/16	.562	1.65	.250
62PW-6	3/8	.625	1.66	.312
62PW-8	1/2	.750	1.82	.375

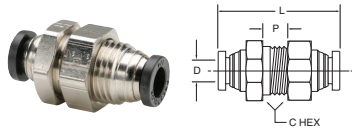

62PWBH Bulkhead Union (Nickel Plated)

PART NO.	TUBE SIZE	BULKHEAD HOLE DIA. B	C HEX	P MAX.	L	D
62PWBH-4	1/4	9/16	11/16	.29	1.43	.188
62PWBH-5	5/16	5/8	3/4	.60	1.65	.250
62PWBH-6	3/8	3/4	7/8	.54	1.66	.312
62PWBH-8	1/2	7/8	1	.66	2.04	.375

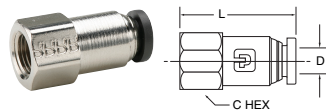

66PW Female Connector (Nickel Plated)

PART NO.	TUBE SIZE	PIPE THREAD (NPTF)	C HEX	L	FLOW DIA. D
66PW-4-2	1/4	1/8	9/16	1.17	.188
66PW-4-4	1/4	1/4	11/16	1.38	.188
66PW-5-2	5/16	1/8	9/16	1.25	.250
66PW-5-4	5/16	1/4	11/16	1.45	.250
66PW-6-4	3/8	1/4	11/16	1.46	.312
66PW-6-6	3/8	3/8	13/16	1.51	.312

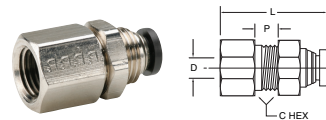

66PWBH Female Bulkhead (Nickel Plated)

PART NO.	TUBE SIZE	THREAD (NPTF)	C HEX	P MAX.	L	FLOW DIA. D	BULKHEAD HOLE DIA.
66PWBH-4-4	1/4	1/4	11/16	.24	1.35	.188	9/16
66PWBH-6-6	3/8	3/8	1	.22	1.47	.312	7/8
66PWBH-8-6	1/2	3/8	1 1/4	.35	1.56	.344	1

W68PW Male Connector (Nickel Plated)

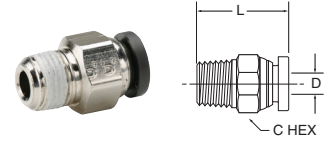

PIPE PART NO.	TUBE SIZE	THREAD (NPTF)	C HEX	L	FLOW DIA. D
W68PW-4-2	1/4	1/8	1/2	.89	.188
W68PW-4-4	1/4	1/4	9/16	1.00	.188
W68PW-4-6	1/4	3/8	3/4	1.04	.188
W68PW-5-2	5/16	1/8	9/16	1.18	.250
W68PW-5-4	5/16	1/4	9/16	1.04	.250
W68PW-5-6	5/16	3/8	11/16	1.04	.250
W68PW-6-2	3/8	1/8	5/8	1.21	.250
W68PW-6-4	3/8	1/4	5/8	1.08	.312
W68PW-6-6	3/8	3/8	11/16	1.02	.312
W68PW-6-8	3/8	1/2	7/8	1.28	.312
W68PW-8-4	1/2	1/4	13/16	1.44	.344
W68PW-8-6	1/2	3/8	13/16	1.24	.344
W68PW-8-8	1/2	1/2	7/8	1.35	.375

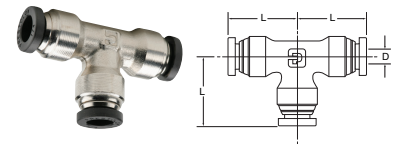

164PW Union Tee (Nickel Plated)

PART NO.	TUBE SIZE	L	FLOW DIA. D
164PW-4	1/4	.85	.188
164PW-5	5/16	.97	.250
164PW-6	3/8	1.01	.250
164PW-8	1/2	1.15	.375

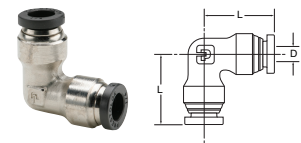

165PW Union Elbow (Nickel Plated)

PART NO.	TUBE SIZE	L	FLOW DIA. D
165PW-4	1/4	.85	.188
165PW-5	5/16	.97	.250
165PW-6	3/8	1.01	.312
165PW-8	1/2	1.15	.375

W169PW Male Elbow Swivel 90° (Nickel Plated)

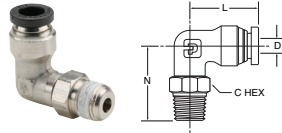

TUBE PART NO.	PIPE SIZE	THREAD (NPTF)	C HEX	L	N	FLOW DIA. D
W169PW-4-2	1/4	1/8	7/16	.85	.92	.156
W169PW-4-4	1/4	1/4	9/16	.85	1.10	.156
W169PW-4-6	1/4	3/8	11/16	.85	1.19	.156
W169PW-5-2	5/16	1/8	9/16	.97	1.02	.250
W169PW-5-4	5/16	1/4	9/16	.97	1.24	.250
W169PW-6-2	3/8	1/8	9/16	1.01	1.02	.250
W169PW-6-4	3/8	1/4	9/16	1.01	1.24	.250
W169PW-6-6	3/8	3/8	11/16	1.01	1.24	.250
W169PW-6-8	3/8	1/2	7/8	1.01	1.48	.250
W169PW-8-4	1/2	1/4	9/16	1.15	1.28	.312
W169PW-8-6	1/2	3/8	11/16	1.15	1.31	.312
W169PW-8-8	1/2	1/2	7/8	1.15	1.52	.312

W171PW Male Run Tee Swivel (Nickel Plated)

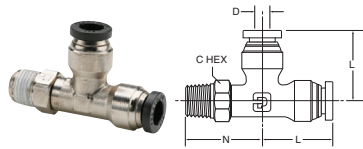

PART NO.	TUBE SIZE	PIPE THREAD (NPTF)	C HEX	L	N	FLOW DIA. D
W171PW-4-2	1/4	1/8	7/16	.85	.92	.156
W171PW-4-4	1/4	1/4	9/16	.85	1.10	.156
W171PW-4-6	1/4	3/8	11/16	.85	1.24	.156
W171PW-5-2	5/16	1/8	9/16	.97	1.02	.250
W171PW-5-4	5/16	1/4	9/16	.97	1.24	.250
W171PW-6-4	3/8	1/4	9/16	1.01	1.24	.250
W171PW-6-6	3/8	3/8	11/16	1.01	1.24	.250
W171PW-8-6	1/2	3/8	11/16	1.15	1.31	.312
W171PW-8-8	1/2	1/2	7/8	1.15	1.52	.312

W172PW Male Branch Tee Swivel (Nickel Plated)

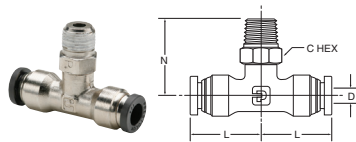

TUBE PART NO.	PIPE SIZE	THREAD (NPTF)	C HEX	L	N	FLOW DIA. D
W172PW-4-2	1/4	1/8	7/16	.85	.92	.156
W172PW-4-4	1/4	1/4	9/16	.85	1.10	.156
W172PW-4-6	1/4	3/8	11/16	.85	1.10	.156
W172PW-5-2	5/16	1/8	9/16	.97	1.02	.250
W172PW-5-4	5/16	1/4	9/16	.97	1.24	.250
W172PW-6-4	3/8	1/4	9/16	1.01	1.24	.250
W172PW-6-6	3/8	3/8	11/16	1.01	1.24	.250
W172PW-8-4	1/2	1/4	9/16	1.15	1.30	.312
W172PW-8-6	1/2	3/8	11/16	1.15	1.31	.312
W172PW-8-8	1/2	1/2	7/8	1.15	1.52	.312

HPB Equal Union

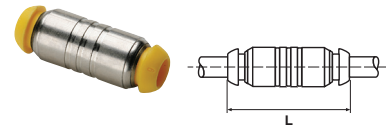

PART NO.	TUBE SIZE (MM)	L
HPB6	6	36.0
HPB8	8	38.0
HPB10	10	48.0
HPB12	12	48.0

WPB Bulkhead Union

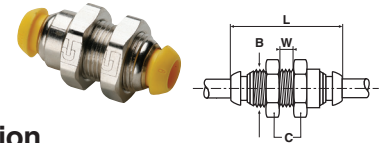

PART NO.	TUBE SIZE (MM)	B-MM THREAD	C HEX	L	W	BULKHEAD HOLE DIA.
WPB6	6	M13X1	19	35	6	13MM
WPB8	8	M15X1.25	22	36	6	16MM
WPB10	10	M18X1	22	43	8	18MM
WPB12	12	M23X1.5	27	46	10	23MM

F3PB Male Connector BSPT

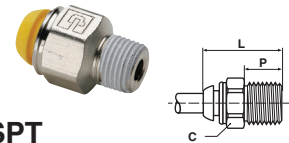

PART NO.	TUBE SIZE (MM)	BSPT	C HEX	L
F3PB6-1/8	6	1/8	14	24.0
F3PB6-1/4	6	1/4	14	24.0
F3PB8-1/8	8	1/8	17	28.0
F3PB8-1/4	8	1/4	17	28.5
F3PB8-3/8	8	3/8	17	26.5
F3PB10-1/4	10	1/4	19	35.5
F3PB10-3/8	10	3/8	19	33.0
F3PB10-1/2	10	1/2	22	31.0
F3PB12-1/4	12	1/4	22	36.5
F3PB12-3/8	12	3/8	22	36.0
F3PB12-1/2	12	1/2	22	36.0

JPB Equal Tee

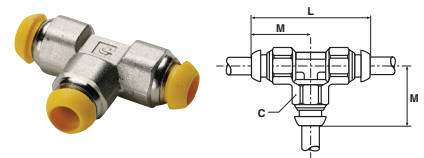

PART NO.	TUBE SIZE (MM)	C	L	M
JPB6	6	12	40	20
JPB8	8	14	44	22
JPB10	10	17	56	28
JPB12	12	22	60	30

B

B

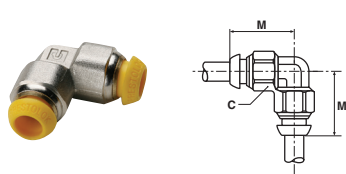

EPB Equal Elbow

PART NO.	TUBE SIZE (MM)	C HEX	M
EPB6	6	12	20.0
EPB8	8	14	22.0
EPB10	10	17	28.0
EPB12	12	22	30.0

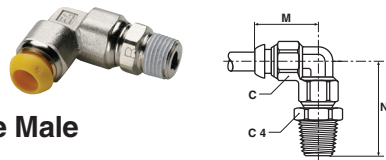

C63PB Adjustable Male Elbow BSPT

PART NO.	TUBE SIZE (MM)	BSPT	C HEX	C4 HEX	M	N
C63PB6-1/8	6	1/8	12	11	20	28.0
C63PB6-1/4	6	1/4	12	14	20	31.0
C63PB8-1/8	8	1/8	14	14	22	30.0
C63PB8-1/4	8	1/4	14	14	22	33.0
C63PB8-3/8	8	3/8	14	17	22	34.5
C63PB10-1/4	10	1/4	17	17	28	40.0
C63PB10-3/8	10	3/8	17	17	28	39.0
C63PB12-1/4	12	1/4	22	19	30	42.0
C63PB12-3/8	12	3/8	22	19	30	41.0
C63PB12-1/2	12	1/2	22	22	30	44.5

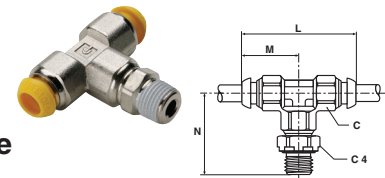

S63PB Swivel Male Branch Tee BSPT

PART NO.	TUBE SIZE (MM)	BSPT	C HEX	C4 HEX	L	M	N
S63PB6-1/8	6	1/8	12	11	40	20	28.0
S63PB6-1/4	6	1/4	12	14	40	20	31.0
S63PB8-1/8	8	1/8	14	14	44	22	30.0
S63PB8-1/4	8	1/4	14	14	44	22	33.0
S63PB8-3/8	8	3/8	14	17	44	22	34.5
S63PB10-1/4	10	1/4	17	17	56	28	40.0
S63PB10-3/8	10	3/8	17	17	56	28	39.0
S63PB12-1/4	12	1/4	22	19	60	30	42.0
S63PB12-3/8	12	3/8	22	19	60	30	41.0
S63PB12-1/2	12	1/2	22	22	60	30	44.5



FNPB Plug

PART NO.	TUBE SIZE (MM)
FNPB6	6
FNPB8	8
FNPB10	10
FNPB12	12

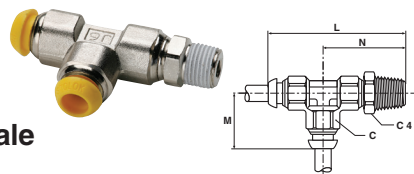

R63PB Swivel Male Run Tee BSPT

PART NO.	TUBE SIZE (MM)	BSPT	C HEX	C4 HEX	L	M	N
R63PB6-1/8	6	1/8	12	11	48.0	20	28.0
R63PB6-1/4	6	1/4	12	14	51.0	20	31.0
R63PB8-1/8	8	1/8	14	14	52.0	22	30.0
R63PB8-1/4	8	1/4	14	14	55.0	22	33.0
R63PB8-3/8	8	3/8	14	17	56.5	22	34.5
R63PB10-1/4	10	1/4	17	17	68.0	28	40.0
R63PB10-3/8	10	3/8	17	17	67.0	28	39.0
R63PB12-1/4	12	1/4	22	19	72.0	30	42.0
R63PB12-3/8	12	3/8	22	19	71.0	30	41.0
R63PB12-1/2	12	1/2	22	22	74.5	30	44.5